

Fieldpiece®

SMAN™ Refrigerant Manifold + Micron Gauge (3 Port)

OPERATOR'S MANUAL Model SM380V

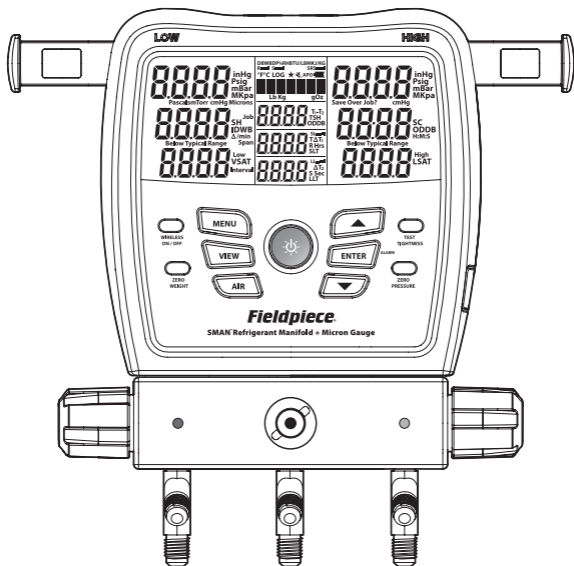

Contents

- Important Notice** 4
 - Class A2L/A2/A3 Refrigerant Safety Notice
 - Warnings

- Quick Start** 5
 - What's Included

- Description** 6
 - Features
 - Display
 - Front View
 - Rear View

- Operation.** 14
 - Buttons
 - Recent Refrigerants
 - VIEW Select
 - AIR Select
 - Superheat (SH) and Subcooling (SC)
 - Target Superheat (TSH)
 - Deep Vacuum
 - Test Tightness (Pressure Test)
 - Test for Noncondensables

- Menu** 22
 - Data Logging
 - Auto Power Off (APO)
 - Temperature Calibration
 - Wireless Measurement Sources
 - Target Superheat (TSH) Sources
 - Units
 - Vacuum Alarms
 - Backlight Timer
 - Advanced Pressure Calibration
 - Firmware View and Update
 - Restore User Settings
 - Delete Log File
 - Format Internal Flash Drive

- Maintenance.** 35
 - Cleaning
 - Battery Replacement
 - Using Different Refrigerants

- Specifications** 36
 - Temperature
 - Pressure
 - Deep Vacuum
 - Wireless Compatibility
 - Manifold Diagram

- Compliance** 39
- Limited Warranty** 42

Important Notice

This is not a consumer product. Only qualified personnel trained in service and installation of A/C and/or refrigeration equipment shall use this product.

Read and understand this operator's manual in its entirety before using your SMAN Refrigerant Manifold to prevent injury or damage to you or equipment.

Class A2L/A2/A3 Refrigerant

Safety Notice

Systems using class A2L (mildly flammable), class A2 (flammable), or class A3 (highly flammable) refrigerants can be tested safely ONLY by qualified personnel explicitly trained in the use and handling of those refrigerants. This manual is in no way a replacement for proper training.



WARNINGS

- Do not apply more than 800 psig to any port of the manifold.
- Ground properly when testing A2L/A2/A3 (hydrocarbon) refrigerants.
- Do not use in the vicinity of explosive substances.
- Inhalation of high concentrations of refrigerant vapor can block oxygen to the brain causing injury or death.
- Refrigerant liquid can cause frostbite.
- Follow all equipment manufacturer's testing procedures above those in this manual in regards to properly servicing their equipment.

Quick Start

1. Install the included six AA batteries into rear battery compartment.
2. Press center blue button for 2 seconds to turn on your new SMAN manifold.
3. Connect your hoses and pipe clamps to the SMAN manifold and to the system.
4. View live pressures and temperatures.
5. Use arrow buttons to select a refrigerant and view calculations in real-time!

What's Included

- SM380V SMAN Refrigerant Manifold (3 Port)
- (2) TC24 Type K Pipe Clamp Thermocouples
- (1) ATA1 Type K Bead Thermocouple w/Clip
- (1) Year Warranty
- Operator's Manual

Description

SMAN™ Refrigerant Manifolds give you the trust needed for doing the job right the first time.

Your new Fieldpiece manifold has been upgraded for ultimate field protection and long range wireless communication. The fully rubberized case seals and protects from dust, bumps, and light rain. Use the heavy duty hook to hang it in your work vehicle while protected by its large padded soft case.

Model SM380V is your testing hub at the jobsite. In addition to the included thermocouples, you can connect wirelessly to psychrometers, pipe clamps, and even a refrigerant scale. For example, assign one psychrometer (model JL3RH) to return air and another to supply air to view live temperature split across the evaporator directly.

View all your measurements and live calculations on the extra large LCD or from a distance on your mobile device. A rolling list of your 10 most recently used refrigerants is stored at the top of the main refrigerant list for quick selection.

Verify proper charge by comparing actual superheat (SH) with target superheat (TSH). Use the outdoor dry bulb thermocouple and an optional indoor psychrometer for live TSH calculations.

Pressure sensors automatically compensate for altitude and weather changes. Use the internal vacuum gauge for fast and convenient monitoring of your evacuations.

Features

Job Link® System Ready

- Long Wireless Range (350 feet/106 meters)
- Connect to Your Mobile Device Directly (page 38)
- Connect Job Link Tools Directly (page 38)

Real-time Calculations

- Superheat and Subcooling
- Vapor Saturation and Liquid Saturation
- Target Superheat (requires model JL3RH for real-time)
- T1-T2

(3) Type K Thermocouple Jacks

- Suction Line
- Liquid Line
- Outdoor Ambient

(3) 1/4" Ports

Built-in Micron Gauge

Tightness Test

Recent Refrigerant List

Sealed Sight Glass

Heavy Duty Rubberized Construction

Rugged Hanging Hook

Operation in the Rain (IP54)

Data Logging with USB Export

Display

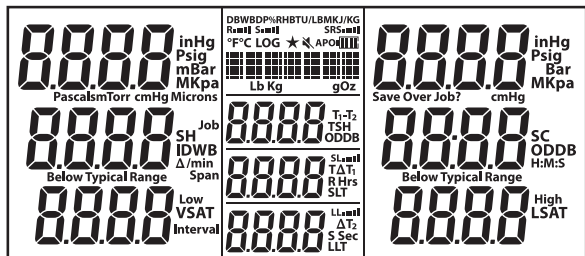

°F: Temperature (Fahrenheit)

°C: Temperature (Celsius)

Psig: Pressure (pounds/in²)

Bar: Pressure

MPa: Pressure (megapascals)

kPa: Pressure (kilopascals)

inHg: Negative Pressure (inches of mercury)

cmHg: Negative Pressure (centimeters of mercury)

Microns: Vacuum (microns of mercury)

Pascals: Vacuum

mBar: Vacuum (millibar)

mTorr: Vacuum (millitorr)

Torr: Vacuum (equivalent to mmHg)

Δ/min: Vacuum Rate (differential per minute)

h:m:s: Hours:Minutes or Minutes:Seconds

SH: Superheat (suction line - vapor saturation)

SC: Subcooling (liquid saturation - liquid line)

VSAT: Vapor Saturation Temperature (from P-T chart)

LSAT: Liquid Saturation Temperature (from P-T chart)

TSH: Target Superheat (calculated from IDWB and ODDB)

T1-T2: Measurement Differential

SLT: Suction Line Temperature (low side)

LLT: Liquid Line Temperature (high side)

ODDB: Outdoor Dry Bulb Temperature

IDWB: Indoor Wet Bulb Temperature

LOG: Data Logging in Progress

Job: Job Slot (1-9) of Data Log

Span: Hours (Hrs) of Data Logging

Interval: Seconds (Sec) Between Logged Measurements

R: Return Psychrometer

S: Supply Psychrometer

DB: Dry Bulb from Psychrometer

WB: Wet Bulb from Psychrometer

DP: Dew Point from Psychrometer

%RH: Relative Humidity from Psychrometer

BTU/LBM: Enthalpy from Psychrometer (BTU per pound mass)

KJ/KG: Enthalpy from Psychrometer (kilojoules per kilogram)

TΔT: Target Dry Bulb Split from Psychrometers

ΔT: Dry Bulb Split from Psychrometers

Lb: Pounds (from wireless scale)

Oz: Ounces (from wireless scale)

Kg: Kilograms (from wireless scale)

g: Grams (from wireless scale)

APO: Auto Power Off Enabled

★ : Top 10 Refrigerant Selected

🔊 : Speaker Turned Off

🔋 : Battery Life Remaining

📶 : Wireless Signal Strength

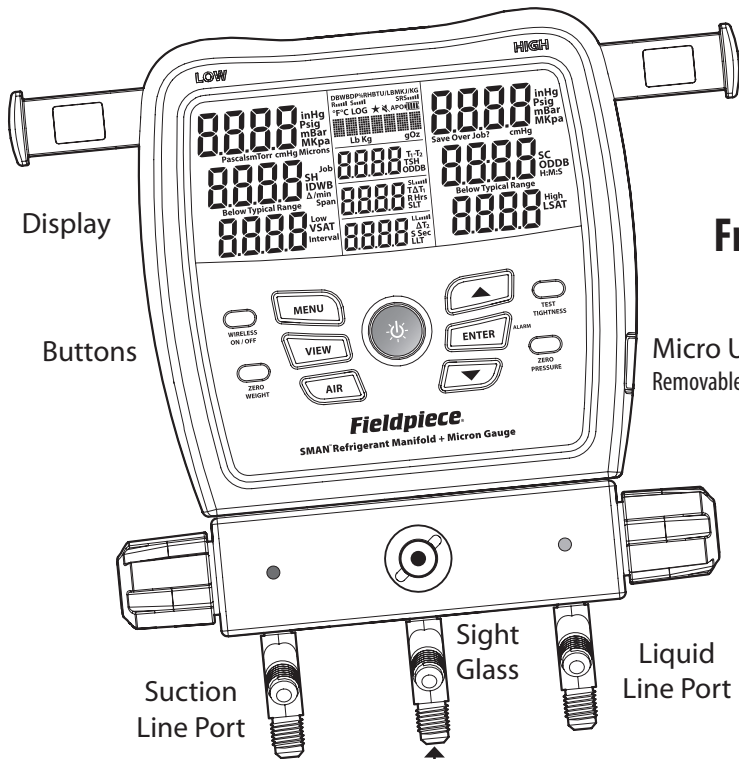

Display

Buttons

Front View

Micro USB Port
Removable rubber cover

Pipe Clamp Storage Arms
Metal shorting blocks are for
Rapid Rail™ Thermocouple
model JL3PC (sold separately)



(LOW) Suction Line Port Valve
(HIGH) Liquid Line Port Valve

Suction
Line Port

Sight
Glass

Liquid
Line Port

Refrigerant Port
Connect to a refrigerant cylinder
directly, to a recovery machine,
or to a vacuum pump.

Fieldpiece 8CFM Vacuum
Pump model VP85
(sold separately)

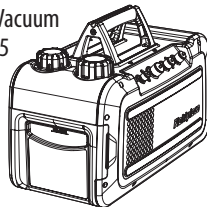

Fieldpiece Recovery
Machine model MR45
(sold separately)



Rear View

Battery Cover Screws

Steel Hanging Hook

Battery Door Finger Pull

4 Digit Job Link® System ID
Use when connecting to the Job Link
Mobile App for testing and reporting

(LLT) Liquid Line
Thermocouple Jack
Shown not inserted enough

(ODDB) Outdoor
Thermocouple Jack
Shown without thermocouple

(SLT) Suction Line
Thermocouple Jack
Shown fully inserted

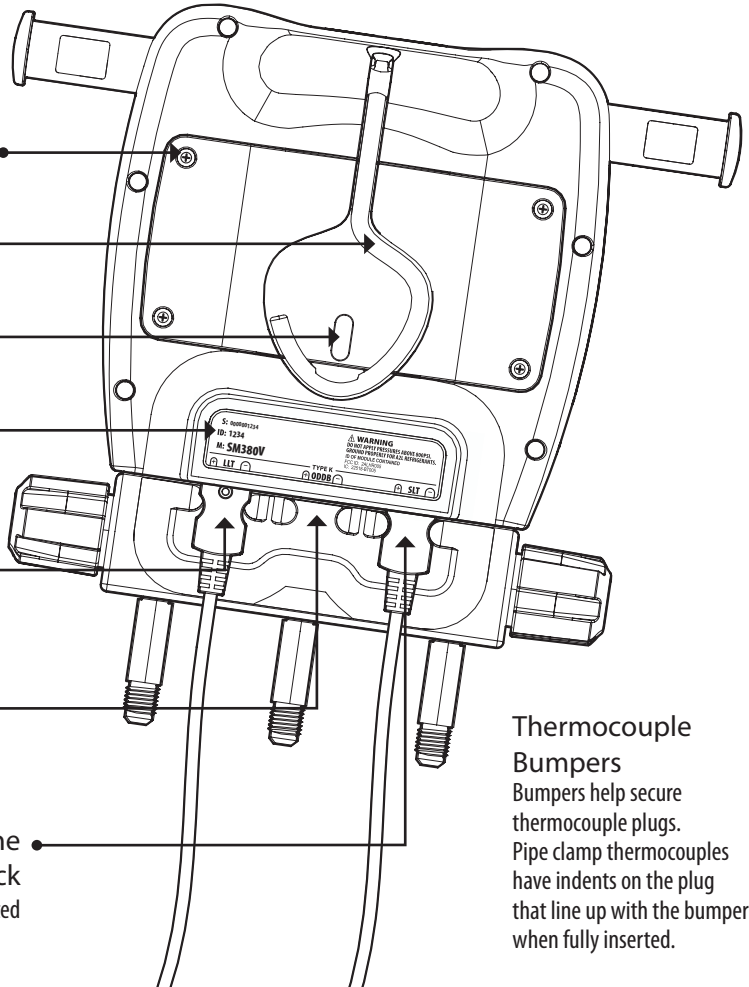

Thermocouple Bumpers
Bumpers help secure thermocouple plugs. Pipe clamp thermocouples have indents on the plug that line up with the bumper when fully inserted.

Operation

Buttons

A beep sounds when a button is pressed. A double beep sounds when a button is pressed and the function is not possible at that time. The speaker can be muted altogether (page 22).

 Press 2 sec to toggle power. Press to toggle backlight.

  Scroll through refrigerants or change values.

ENTER: Confirm a changed value or activate an ALARM (page 18).

MENU: Enter the menu (page 22) or exit a mode.

VIEW: Display ODDB, TSH, or T1-T2 (page 15).

AIR: Display SLT/LLT or various return and supply air measurements from optional psychrometers (page 15).

WIRELESS ON/OFF: Toggle wireless communication ON/OFF. Turn wireless OFF to increase battery life.

ZERO WEIGHT: Press 2 sec to zero (tare) weight from a wireless scale (page 26).

TEST TIGHTNESS: Enter tightness test setup (page 20).

ZERO PRESSURE: Press 2 sec to zero the displayed pressures.

Recent Refrigerants (★)

A rolling list of your 10 most recent refrigerants, indicated by a ★, is stored above the main list. When you power off your manifold, the current refrigerant is added automatically to this dynamic list of 10.

VIEW Select

Press **VIEW** to cycle through ODDB (outdoor dry bulb), TSH (target superheat), and T1-T2 (middle display - bottom display).

ODDB: Live reading of the rear ODDB thermocouple jack. ODDB does not show if set to manual value (page 27).

TSH: Live target superheat calculated from ODDB and IDWB. Each of these measurements can be live or manually entered (page 17).

T1-T2: Live simple subtraction of the bottom display (T2) from the middle display (T1). *With SLT and LLT showing, you can check for a temperature drop across a filter drier. With R and S showing, you can check the effect of the indoor unit. With TΔT and ΔT showing, you can see how close the actual ΔT is to the target.*

AIR Select

Press **AIR** to display various calculations and measurements from Job Link system psychrometers you've assigned (page 26). The parameter is briefly shown when pressed, then shown at the top of the LCD.

Press **AIR** for >1 second to view SLT/LLT.

SLT: Live reading of suction line temperature.

LLT: Live reading of liquid line temperature.

R: Live reading from return air psychrometer.

S: Live reading from supply air psychrometer.

TΔT: Live target dry bulb split from psychrometers.

ΔT: Live actual dry bulb split from psychrometers.

Superheat (SH) and Subcooling (SC)

Superheat is the amount of heat added to refrigerant after changing to a vapor in the evaporator. Subcooling is the amount of heat removed from refrigerant after changing to a liquid in the condenser. View both live at the same time!

1. Use **ARROWS** to select the system refrigerant.
 2. Close all manifold valves.
 3. Connect EPA approved refrigerant hoses to LOW and HIGH side ports.
 4. Fully plug pipe clamp thermocouples into SLT and LLT rear jacks.
 5. Hand tighten both the LOW side hose to suction line service port and the HIGH side hose to the liquid line service port.
 6. Clamp the SLT thermocouple to the suction line between the evaporator and compressor, at least 6 inches from the compressor.
 7. Clamp the LLT thermocouple to the liquid line between the condenser and metering device, as close to the service port as possible.
 8. Purge hoses as you open HIGH and LOW manifold valves.
 9. View superheat and subcooling in real-time.
- Ensure system has stabilized before using superheat or subcooling to adjust the charge of the system.
 - To add or remove refrigerant connect the tank/cylinder/machine to the center refrigerant port. Use manifold valves to precisely charge or recover refrigerant as needed. Follow recommended charging or recovery practices from equipment manufacturer and training.
 - When superheat and/or subcooling cannot be calculated, “- - -” will be displayed. If superheat and/or subcooling is negative, “Below Typical Range” will show. In rare cases this is normal, but usually a thermocouple is disconnected or the selected refrigerant is incorrect.

Target Superheat (TSH)

Compare target superheat (TSH) to actual superheat (SH) when charging fixed orifice air conditioning systems. TSH is continually calculated from indoor wet bulb (IDWB) and outdoor dry bulb (ODDB) temperatures.

IDWB: By default, this is a manually set value of 60.0°F.

For a live measurement, assign the optional model JL3RH wireless psychrometer (page 26).

ODDB: By default, this is the live measurement of the ODDB thermocouple jack. If you prefer a static measurement, assign a manual value (page 27).

1. Connect the included type K bead thermocouple to the ODDB thermocouple jack. Use the alligator clip to locate the bead in a shaded area of the condenser to measure the temperature of air entering the condenser.
2. Press **VIEW** until ODDB is displayed to verify the measurement. *If you changed ODDB to a manually set value, it will be used to calculate TSH but will not be displayed.*
3. Measure IDWB after the filter, just in front of the indoor coil. If a psychrometer is assigned, you can press **AIR** until wet bulb is displayed to verify the measurement.
4. Press **VIEW** until TSH is displayed.

Deep Vacuum

Follow recommended evacuation practices from equipment manufacturer and training. Alarms can be adjusted in the MENU (page 28).

1. Close all manifold valves (including shutoff valve to pump).
2. Setup your tools and equipment (see diagram).
*Connect HIGH port to liquid line service port.
Connect LOW port to suction line service port.
Connect refrigerant (middle) port to vacuum pump **making sure to have a shutoff valve between the pump and manifold.***
3. Turn on your vacuum pump.
4. Open shutoff valve between pump and manifold.
The vacuum sensor is now exposed to your pump, but it will not display until HIGH/LOW manifold valves are opened. This ensures the measurement is of the system and not just the manifold.
5. Open HIGH and LOW manifold valves.
6. Press **ALARM** to activate the low alarm.
*The stopwatch starts. The rate of change is displayed in units per minute. The smaller the rate of change, the closer you are to stabilization. You may need to improve your setup if rate slows well before reaching your desired vacuum (see *Tips for Better Evacuations*).*
7. Once the the low alarm level is reached, the backlight blinks and alarm sounds. Press any button (other than ENTER) to silence alarm.
8. Close shutoff valve to block the pump.
Do not close HIGH and LOW valves or you'll block the system and measure just the manifold!
9. Turn off your vacuum pump.
10. Press **ALARM** to activate the high alarm and start the stopwatch.
11. Once the high alarm level is reached, the backlight blinks, alarm sounds, and the stopwatch stops. Press any button (other than ENTER) to silence alarm.
12. Close HIGH and LOW manifold valves.
The vacuum sensor is now blocked from the system (page 39).

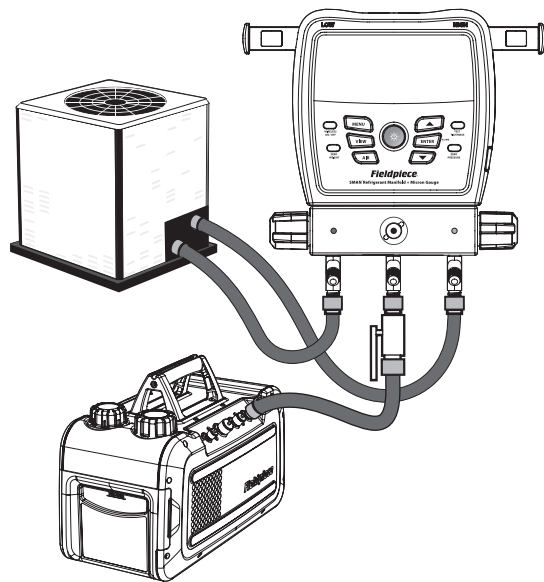

Tips for Better Evacuations

- Remove schrader cores and depressors with a core removal tool.
- Use shortest vacuum rated hoses with largest diameter available.
- Do not evacuate through hoses with low loss fittings.
- Inspect the rubber seals at both ends of your hoses for damage.
- Change pump oil before and during the job. Change pump oil on-the-fly without losing vacuum with Fieldpiece vacuum pumps.
- When the vacuum pump is blocked, a slow rise that stabilizes may signify moisture is still present in the system. A continuous rise to atmosphere indicates a leak. Check hoses, tools, or the system itself.
- Measurements are less representative of the entire system when the vacuum pump is on because pumping creates a pressure gradient. Block the pump and allow the system to stabilize before assuming the measurement is of the entire system.

Test Tightness (Pressure Test)

After working on a refrigerant-side component of an emptied system, it's a good idea to pressurize the system with dry nitrogen and check for pressure drops before evacuation.

1. Pressurize the system with dry nitrogen. *Pressure levels vary with the equipment you're testing. Always check with the manufacturer.*
 2. Connect the low side (suction line) port to the system and wait for the pressure to stabilize. *You can connect the high side (liquid line) as well to help monitor stability, but the pressure differential (P.diF) calculation is only using the low side sensor.*
 3. Attach SLT clamp to the pipe you're going to pressurize.
*This temperature is used to compensate for any temperature changes between the start and end of the test.
To deactivate temperature compensation, unplug or unassign SLT before starting the test; SLT will not be shown or used.*
 4. Press **TEST TIGHTNESS** to prepare test.
 5. Press **ENTER** to start the test.
*The stopwatch starts.
Real-time compensated pressure change is labeled P.diF.
Real-time temperature is labeled SLT.
Real-time temperature change is labeled ΔT .*
 6. Press **ENTER** to stop the test.
*The stopwatch, P.diF, and ΔT freeze.
If P.diF is negative, there may be a leak in the system.
If P.diF is positive, SLT or nitrogen temperature may be unstable.
High and low side pressures and SLT continue to display, but they are no longer being used.*
 7. Press **ENTER** to exit the test.
- To save battery life, the screen will turn off after 3 hours of testing, but will continue to test. Press any button to turn the screen on.

Test for Noncondensables

If head pressure seems high even after cleaning coils, optimizing airflow, and other routine maintenance, you may have noncondensables trapped in the system. Noncondensables can reduce efficiency, performance, and put extra stress on system components. Noncondensables can enter the system in many ways, and your initial system service may be following years of poor service that introduced the noncondensables.

1. Use **ARROWS** to select the system refrigerant.
2. Unpower the compressor, but allow the condenser fan to run.
3. Connect high side port to the system to view system pressure.
4. Clamp one thermocouple to the discharge line.
5. Clamp the other thermocouple to the liquid line.
6. Clip the ODDB thermocouple to measure the air entering the condenser.
7. Monitor all three temperatures until they all stabilize and show the same value.
8. View the subcooling (SC) calculation on the display.
*The closer SC is to 0.0°, the fewer noncondensables are trapped.
Depending on the system, a negative SC may suggest a need to recover, evacuate, and charge with virgin refrigerant.*

Menu

Press MENU to enter the menu where most settings are located. Use arrows to scroll through the menu and press ENTER to select one of the below menu items.

LogData: Enter data logging setup mode (page 23).

(StopLog): If data logging, stop the log (page 23).

AutoOff: Enter auto off timer setup mode (page 24).

CalTemp: Enter calibration mode for Type K jacks (page 25).

Wireless Sources: Enter wireless source setup mode (page 26).

TSH Sources: Enter target superheat source setup mode (page 27).

Units: Enter units setup mode (page 28).

Vac Alarms: Enter vacuum alarm setup mode (page 28).

Mute: If unmuted, mute the speaker.

(Unmute): If muted, unmute the speaker.

Backlight Timer: Enter backlight timer setup mode (page 29).

Adv Pressure Cal: Enter advanced calibration mode for pressure sensors (page 30).

F Ware: Enter firmware view and update mode (page 32).

Restore Settings: Enter restore factory settings mode (page 33).

(Delete Log File): If a log file is saved to the internal flash drive, enter delete log file mode (page 34).

Format Drive: Enter format drive mode (page 34).

Data Logging

Log measurements and resulting calculations, such as Superheat, at chosen spans and intervals. Save up to 9 Jobs (logs) to the internal flash drive.

MENU/LogData

1. Use **ARROWS** to scroll through Jobs.
The display will alternate between the % free space on the drive and the % of space the chosen Job uses.
 2. Press **ENTER** to select.
If a Job already exists in that slot, use ARROWS then ENTER to choose whether or not you want to save over that Job.
 3. Use **ARROWS** to set the Span (total time).
It's a good idea to use new batteries if setting up a long span. If batteries run out during a Job, the log will automatically stop and save, then the SMAN manifold will turn off.
 4. Press **ENTER** to select.
 5. Use **ARROWS** to set the Interval (time between measurements).
 6. Press **ENTER** to select and begin logging data until the Span ends.
LOG will blink to indicate the log is still active.
- Press **MENU** to exit setup at any time.
 - Press **MENU** and select **StopLog** to stop the Job and return to standard operation. The Job will be saved.
 - To save battery life, the screen will turn off after 3 hours of logging, but will continue to log. Press any button to turn the screen on.
 - Some buttons and features (including auto power off) are disabled until the Job ends.
 - Jobs are saved as .csv files.
 - Connect to your computer via the micro USB port under the removable rubber cover. View its internal flash drive just like any other USB drive.

Auto Power Off (APO)

To save battery life, your SMAN manifold automatically powers off after a set time of no button presses.

MENU/AutoOff

1. Use **ARROWS** to scroll through times (default is 30 min).
 2. Press **ENTER** to select and exit. *If changes were made, choose whether or not you want to save changes.*
- Press **MENU** to exit at any time. *If changes were made, choose whether or not you want to save changes.*
 - APO is automatically disabled when data logging.

Temperature Calibration

Thermocouples (T/C) are not calibrated directly. Instead, each T/C jack (ODDB, SLT, LLT) must be calibrated to the particular T/C that is plugged into it. Though it's possible for a calibration to hold for years, it's best practice to calibrate regularly if only to verify accuracy.

Calibration is quick and easy, requiring just a known temperature to calibrate to. Ice water is probably the most accurate and readily available known temperature (32.0°F, 0.0°C) in the field.

MENU/CalTemp

1. Stabilize a large cup of ice water by stirring. Pure, distilled water will be the most accurate.
 2. Immerse the sensing end of the thermocouple in the ice water.
 3. Use **ARROWS** to select the temperature you want to calibrate (SLT, LLT, or ODDB).
 4. Press **ENTER** to select.
 5. Use **ARROWS** to adjust the temperature to match 32.0°F (0.0°C) making sure the ice water is continually stirred. *The calibration range is limited to $\pm 7^{\circ}\text{F}$ ($\pm 3.8^{\circ}\text{C}$) in order to help prevent mistakes.*
 6. Press **ENTER** to save and return to the list of temperatures.
- Press **MENU** to exit at any time. *If changes were made, choose whether or not you want to save changes.*
 - If you have a wireless thermocouple (model JL3PC) assigned and wireless is on, calibration is for the wireless thermocouple.
 - Calibration of a wireless thermocouple (model JL3PC) does not override a wired thermocouple calibration. You can switch between wired and wireless without having to recalibrate.

Wireless Measurement Sources

Assign wireless Job Link system tools to core manifold measurements such as pipe temperature or to broader measurements such as refrigerant weights and psychrometrics.

Wireless OFF: Line temperatures (SLT and LLT) are automatically assigned to their type K jacks.

Wireless ON: SLT and LLT type K jacks DO NOT override an assigned wireless source.

MENU/Wireless Sources

1. Use **ARROWS** to scroll through the list of measurements.
 2. Press **ENTER** to select.
 3. Turn on any wireless sources you want to assign.
If your Job Link system tool has a selector switch, ensure it's set to match the measurement.
 4. Use **ARROWS** to scroll through detected measurement sources.
Job Link system tools are displayed by their 4 digit ID, usually found on the back of the tool.
 5. Press **ENTER** to select and return to the list of measurements.
- Press **MENU** to exit at any time. *If changes were made, choose whether or not you want to save changes.*
 - Most Job Link system tools have a switch that selects a side of the system. Set it to match the measurement you're assigning it to.
 - Select **Clear** to set a source to its factory default source. This is useful when you want to use a previously assigned tool at the job site, but do not want to use it with the SMAN manifold.
 - A wireless Return psychrometer is assigned to both Return air and IDWB (page 17) when selected.

Target Superheat (TSH) Sources

Target superheat is calculated from outdoor dry bulb (ODDB) entering the condenser coil and indoor wet bulb (IDWB) entering the evaporator coil. Assign a wireless psychrometer to return air and plug in a thermocouple to ODDB for real-time comparison of target vs actual superheat.

MENU/TSH Sources

1. Use **ARROWS** to toggle between IDWB and ODDB.
 2. Press **ENTER** to select.
 3. Use **ARROWS** to scroll through detected measurement sources.
Job Link system tools are displayed by their 4 digit ID, usually found on the back of the tool. ODDB cannot be set to wireless.
 4. Turn on any wireless sources you want to assign.
If your Job Link system tool has a selector switch, ensure it's set to match the measurement.
 5. Press **ENTER** to select and exit or go to next.
- Press **MENU** to exit at any time. *If changes were made, choose whether or not you want to save changes.*
 - Most Job Link system tools have a switch that selects a side of the system. Set it to match the measurement you're assigning it to.
 - Select **Clear** to set a source to its factory default source. This is useful when you want to use a previously assigned tool at the job site, but do not want to use it with the SMAN manifold.
 - A wireless Return psychrometer is assigned to both Return air (page 15) and IDWB when selected.
 - Turning wireless on/off does not change the assigned source.
 - If ODDB is set to a manually set value, the thermocouple jack is deactivated even if a thermocouple is plugged in.

Units

Each measurement can have its own unit of measure.

MENU/Units

1. Use **ARROWS** to scroll through the list of measurements.
 2. Press **ENTER** to select.
 3. Use **ARROWS** to scroll through units of measure.
 4. Press **ENTER** to select and return to the list of measurements.
- Press **MENU** to exit at any time. *If a change was made before pressing ENTER, choose whether or not you want to save the change.*

Vacuum Alarms

Set high and low vacuum alarms so you know when you've reached an appropriate vacuum (Low) and time how long it takes to rise after blocking the pump from the system (High).

MENU/Vac Alarms

1. Use **ARROWS** to toggle between high and low alarm.
 2. Press **ENTER** to select.
 3. Use **ARROWS** to adjust the alarm trigger.
 4. Press **ENTER** to select and exit or go to next.
- Press **MENU** to exit at any time. *If changes were made, choose whether or not you want to save changes.*
 - The low alarm cannot go higher than the high alarm.
 - The high alarm cannot go lower than the low alarm.
 - Press **ENTER (ALARM)** while in deep vacuum to activate the next alarm (None >> Low >> High >> None).

Backlight Timer

The backlight turns off automatically after a set time of no button presses.

MENU/Backlight Timer

1. Use **ARROWS** to scroll through times (default is 2 min).
 2. Press **ENTER** to select and exit. *If changes were made, choose whether or not you want to save changes.*
- Press **MENU** to exit at any time. *If changes were made, choose whether or not you want to save changes.*

Advanced Pressure Calibration

Typical HVACR service does not require this procedure, but you can occasionally calibrate the pressure sensors to maintain highest accuracy.

It works by measuring the temperature of virgin refrigerant and applying an offset to match the pressure to that refrigerant's P-T chart.

1. Calibrate a beaded thermocouple to the ODDB jack (page 25).
2. Store a virgin refrigerant cylinder, upright and untouched, in the stable ambient environment for at least 24 hours.
3. Leaving the cylinder in the same place it was left to stabilize, connect the cylinder to either the HIGH or LOW side port.
4. Cap the 2 unused ports.

If you don't have caps with seals, you can connect both ends of a refrigerant hose to the unused ports or hose seats. Some refrigerant will remain in the hoses which you need to recover after calibration.

5. Use **ARROWS** to select the refrigerant type in the cylinder.
6. Use tape to attach the ODDB thermocouple bead halfway up the cylinder to measure the temperature of the refrigerant.
7. Press **VIEW** if ODDB is not shown.
8. Open both HIGH and LOW side manifold valves.
9. Open the refrigerant cylinder valve.

The pressure inside cylinder should now be displayed on both HIGH and LOW side pressure sensors.

10. Allow the pressure readings and ODDB temperature to stabilize.
11. Press **MENU**.
12. Use **ARROWS** to show **Adv Pressure Cal**.
13. Press **ENTER** to initiate calibration of the pressure sensors.
14. Each pressure sensor will briefly display "Good" if successful or "Err" if unsuccessful, then return to normal operating mode.

Troubleshooting an "Err" message

1. Measured pressure was less than 10 psig.
 - Refrigerant cylinder may be nearly empty.
 - Valves may be closed.
2. Measured pressure was not within ± 3 psig of VSAT pressure on the P-T chart.
 - Thermocouple may not have been calibrated properly.
 - Thermocouple may not have been attached properly to cylinder.
 - Thermocouple may have not been connected to ODDB jack.
 - Refrigerant cylinder pressure was unstable.
 - Refrigerant cylinder temperature was unstable.
 - Refrigerant selected did not match refrigerant in cylinder.

Firmware View and Update

Firmware often becomes available as new refrigerants and features become available.

Before entering this mode, download from www.fieldpiece.com and transfer from the computer to the manifold via the micro USB port on the side.

Or you can initiate an update over the air from your mobile device running the Job Link system mobile app while the version is displayed.

MENU/F Ware

1. View the firmware version on the top line, P/T chart on the second line, and radio region on the bottom line.
 2. *If a new firmware file is found on the internal flash drive the new versions will be shown. Choose whether or not you want to update.*
 3. Once installation begins you will see a bar moving across the screen. "donE" will appear and your SMAN manifold will turn off when finished.
- Press **MENU** to exit at any time before installation begins.
 - During installation, buttons are disabled.
 - User settings are not deleted.
 - Log files are not deleted.

Restore User Settings

Restore factory default user settings when you want a fresh start.

MENU/Restore Settings

1. Use **ARROWS** to select Yes or No.
 2. Press **ENTER** to select and exit.
- Press **MENU** to exit at any time. *If changes were made, choose whether or not you want to save changes.*
 - If you choose to restore, it may take a few seconds before returning to standard operation.

Delete Log File

Clear up space by deleting old logs or just view free space available.

MENU/Delete Log File

1. Use **ARROWS** to scroll through Jobs (logs). *The display will alternate between the % free space on the drive and the % of space the chosen Job uses.*
 2. Press **ENTER** to select a Job to delete. *Choose whether or not you want to delete that Job.*
 3. If you choose to delete, it may take a few seconds to finish. If no more Jobs are found, the manifold returns to standard operation.
- Press **MENU** to exit at any time.

Format Internal Flash Drive

Quickly clear up maximum space by reformatting the internal flash drive. This deletes everything on the drive including log files, firmware update files, and any other files added manually.

MENU/Format Drive

1. Use **ARROWS** to select Yes or No.
 2. Press **ENTER** to select and exit.
- Press **MENU** to exit at any time.
 - If you choose to format, it may take a few seconds before returning to standard operation.
 - User settings are not deleted.

Maintenance

Cleaning

Wipe with damp cloth to clean the exterior. Do not use solvents.

Battery Replacement

The batteries must be replaced when the battery life indicator is empty. Once the batteries are drained beyond operating voltage, “Low Bat” briefly appears and the manifold turns off.

Unscrew the 4 cover screws and pull out the rear battery cover. Replace the 6 AA batteries and properly dispose of the old ones.

Using Different Refrigerants

You can use different refrigerants, but be sure to purge your manifold with nitrogen before connecting to a system with a different refrigerant. Contamination can hurt system performance and cause damage.

Temperature Calibration

See page 25.

Advanced Pressure Calibration

See page 30.

Specifications

Display: LCD (5 inches diagonal)

Backlight: Blue (adjustable duration)

Low Battery Indication:  is displayed when the battery voltage drops below the operating level.

Over Range Display: OL for pressure, ---- for temperature

Auto Power Off: 30 minutes of inactivity (adjustable)

Maximum Manifold Pressure: 800 Psig (5500 kPa)

Battery Type: 6 x AA alkaline

Battery Life: 350 hours typical
(without vacuum, backlight, and wireless)

Radio Frequency: 2.4 GHz

Wireless Range: 350 feet (106 meters) line of sight.
Distance decreases through obstructions.

Data Port: Micro USB (for extracting data logs or updating firmware)

Operating Environment: 32°F to 122°F (0°C to 50°C) at <75% RH

Storage Environment: -4°F to 140°F (-20°C to 60°C) at <80% RH
(with battery removed)

Temperature Coefficient: 0.1 x (specified accuracy) per °C (0°C to 18°C, 28°C to 50°C), per 1.8°F (32°F to 64°F, 82°F to 122°F)

Weight: 4.03 lbs (1.83 kg)

Water Resistant: Designed to IP54

US Patent: www.fieldpiece.com/patents

Refrigerants: New refrigerants are continually being added so be sure to visit www.fieldpiece.com for the latest firmware.

R11	R115	R290	R407A	R414B	R422B	R448A	R500	R600A
R12	R116	R401A	R407C	R416A	R422C	R449A	R501	R601
R13	R123	R401B	R407F	R417A	R422D	R450A	R502	R601A
R22	R124	R402A	R408A	R417C	R424A	R452A	R503	R744*
R23	R125	R402B	R409A	R420A	R427A	R452B	R507A	R1233ZD
R32	R134A	R403B	R410A	R421A	R428A	R453A	R508B	R1234YF
R113	R236FA	R404A	R413A	R421B	R434A	R454B	R513A	R1234ZE
R114	R245FA	R406A	R414A	R422A	R438A	R458A	R600	

*Maximum pressure: 580 Psig (4000 kPa)

Temperature

Sensor Type: Type K thermocouple
(nickel chromium/nickel aluminum)

Jack Type: (3) Type K thermocouple

Range: -50°F to 257°F (-46°C to 125°C), limited by the thermocouple specification. Display range is -95°F to 999.9°F (-70°C to 537.0°C).

Resolution: 0.1°F (0.1°C)

Accuracy: Shown accuracies are after field calibration.
±(1.0°F) -95°F to 200°F, ±(2.0°F) 200°F to 999.9°F;
±(0.5°C) -70°C to 93°C, ±(1.0°C) 93°C to 537.0°C

Pressure

Sensor Type: Absolute pressure sensors

Port Type: (3) 1/4" standard NPT male flare fittings

Pressure Range and Units: 580 Psig (English), 40.00 Bar (Metric), 4.000 MPa (Metric), and 4000 kPa (Metric)

Negative Pressure Range and Units:

29 inHg (English), 74 cmHg (Metric)

Resolution: 0.1 Psig; 0.01 Bar; 0.001 MPa; 1 kPa; 0.1 inHg; 1 cmHg

Negative Pressure Accuracy:

29 inHg to 0 inHg: ±0.2 inHg;

74 cmHg to 0 cmHg: ±1 cmHg

Pressure Accuracy:

0 Psig to 200 Psig: ±1 Psig;

200 Psig to 580 Psig: ±(0.3% of reading + 1 Psig);

0 Bar to 13.78 Bar ±0.07 Bar;

13.78 Bar to 40.00 Bar: ±(0.3% of reading + 0.07 Bar);

0 MPa to 1.378 MPa: ±0.007 MPa;

1.378 MPa to 4.000 MPa: ±(0.3% of reading + 0.007 MPa);

0 kPa to 1378 kPa: ±7 kPa;

1378 kPa to 4000 kPa: ±(0.3% of reading + 7 kPa)

Deep Vacuum

Sensor Type: Thermistor

Port Type: (3) 1/4" standard NPT male flare fittings

Range and Units:

- 50 to 9999 microns of mercury (English),
- 6 to 1330 Pascals (Metric),
- 0.06 to 13.3 mBar (Metric),
- 50 to 9999 mTorr (Metric),
- 0.05 to 10 Torr (Metric, equivalent to mmHg)

Best Resolution:

- 1 micron of mercury (below 2000 microns),
- 1 Pascal (below 250 Pascals),
- 0.001 mBar (below 2.5 mBar),
- 1 mTorr (below 2000 mTorr),
- 0.001 Torr (below 2.5 Torr)

Accuracy @ 77°F (25°C):

- ±(5% of reading + 5 microns of mercury), 50 to 1000 microns
- ±(5% of reading + 1 Pascal), 7 to 133 Pascal
- ±(5% of reading + 0.01 mBar), 0.067 to 1.33 mBar
- ±(5% of reading + 5 mTorr), 50 to 1000 mTorr
- ±(5% of reading + 0.005 Torr), 0.067 to 1 Torr

Wireless Compatibility

Latest compatibility at www.fieldpiece.com

Job Link System Minimum Device Requirement:

BLE 4.0 devices running iOS 7.1 or Android™ Kitkat 4.4

Wireless Measurement Source Assignments:

- Suction line temperature: Fieldpiece model JL3PC (set to blue)
- Liquid line temperature: Fieldpiece model JL3PC (set to red)
- Supply air psychrometer: Fieldpiece model JL3RH (set to blue)
- Return air psychrometer: Fieldpiece model JL3RH (set to red)
- Refrigerant weight scale: Fieldpiece models SRS3, SRS3P

Manifold Diagram

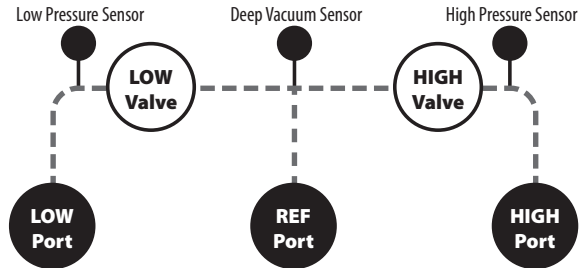

Compliance



EN 300 328



2ALHR005



Regulatory Compliance Mark



Waste Electrical and Electronic Equipment



RoHS
Restriction of Hazardous Substances Compliant

IC: Industry Canada

22518-BT005

FCC Statement

This equipment has been tested and found to comply with the limits for a Class B digital device, pursuant to Part 15 of the FCC Rules. These limits are designed to provide reasonable protection against harmful interference in a residential installation. This equipment generates, uses and can radiate radio frequency energy and, if not installed and used in accordance with the instructions, may cause harmful interference to radio communications. However, there is no guarantee that interference will not occur in a particular installation. If this equipment does cause harmful interference to radio or television reception, which can be determined by turning the equipment off and on, the user is encouraged to try to correct the interference by one or more of the following measures:

1. Reorient the receiving antenna.
2. Increase the separation between the equipment and receiver.
3. Connect the equipment into an outlet on a circuit different from that to which the receiver is connected.
4. Consult the dealer or an experienced radio/TV technician for help.

FCC Caution:

Any changes or modifications not expressly approved by the party responsible for compliance could void the user's authority to operate this equipment.

This device complies with Part 15 of the FCC Rules. Operation is subject to the following two conditions: (1) This device may not cause harmful interference, and (2) this device must accept any interference received, including interference that may cause undesired operation.

This device and its antenna(s) must not be co-located or operating in conjunction with any other antenna or transmitter.

IMPORTANT NOTE: FCC Radiation Exposure Statement:

This equipment complies with FCC radiation exposure limits set forth for an uncontrolled environment. This equipment should be installed and operated with minimum distance 20cm between the radiator & your body.

IC Statement

This device contains licence-exempt transmitter(s)/receiver(s) that comply with Innovation, Science and Economic Development Canada's licence-exempt RSS(s). Operation is subject to the following two conditions:

1. This device may not cause interference.
2. This device must accept any interference, including interference that may cause undesired operation of the device.

L'émetteur/récepteur exempt de licence contenu dans le présent appareil est conforme aux CNR d'Innovation, Sciences et Développement économique Canada applicables aux appareils radio exempts de licence. L'exploitation est autorisée aux deux conditions suivantes :

1. L'appareil ne doit pas produire de brouillage;
2. L'appareil doit accepter tout brouillage radioélectrique subi, même si le brouillage est susceptible d'en compromettre le fonctionnement.

IMPORTANT NOTE: IC Radiation Exposure Statement:

This equipment complies with IC RSS-102 radiation exposure limits set forth for an uncontrolled environment. This equipment should be installed and operated with minimum distance 20cm between the radiator & your body.

Cet équipement est conforme aux limites d'exposition aux rayonnements IC établies pour un environnement non contrôlé. Cet équipement doit être installé et utilisé avec un minimum de 20cm de distance entre la source de rayonnement et votre corps

Limited Warranty

This product is warranted against defects in material or workmanship for one year from date of purchase from an authorized Fieldpiece dealer. Fieldpiece will replace or repair the defective unit, at its option, subject to verification of the defect.

This warranty does not apply to defects resulting from abuse, neglect, accident, unauthorized repair, alteration, or unreasonable use of the machine.

Any implied warranties arising from the sale of a Fieldpiece product, including but not limited to implied warranties of merchantability and fitness for a particular purpose, are limited to the above. Fieldpiece shall not be liable for loss of use of the machine or other incidental or consequential damages, expenses, or economic loss, or for any claim of such damage, expenses, or economic loss.

State laws vary. The above limitations or exclusions may not apply to you.

Obtaining Service

Visit www.fieldpiece.com/rma for the latest information on how to obtain service.

Warranty for products purchased outside of the U.S. should be handled through local distributors. Visit our website to find your local distributor.

SM380V

© Fieldpiece Instruments, Inc 2019; v17