



Condensate removal pumps

Air conditioning - Refrigeration - Heating





Factory (Madagascar)



Headquarter (France)



Factory (China)

FEW WORDS ABOUT SICCOM

SICCOM S.A.S was founded in 1979 and specialises in condensate removal pumps, level and proximity sensors, bimetal heat protection, and interference suppressors for car industry.

SICCOM's expertise means customers can benefit from a range of high added-value products that meet installers' requirements.

SICCOM technology is designed and implemented by its own engineering department, made up of a number of highly qualified engineers and technicians.

SICCOM constantly strives to innovate and now enjoys world-wide success in more than 45 countries

As it has grown, it has opened factories in Madagascar and China, and subsidiaries in Milan, Barcelona and New Delhi alongside its head office in the Paris area.

This international presence means it is able to supply customers regardless of any particular geopolitical situation.

Eco-design

Fully aware that the virtuous eco-design cycle is beneficial to everyone, SICCOM has chosen to fully integrate this approach into its various production phases.

The mini FLOWATCH® 2, the brand's star product, has been the first product illustrating this approach. The environmental impact has been reduced from 5 to 20%, and the life has been multiplied by 2. More recently, the mini FLOWATCH® 0 reached 65.6% of environmental impact reduction for its use phase!

Our approach:

*"Significant environmental improvements,
better service for our customers."*

Certifications

All our sites have received ISO 9001 version 2008 certification. SICCOM and its chinese factory also obtained the ISO TS certification in 2014.

Quality procedures encompass all of the company's services, ensuring optimal quality levels.































Intertek



SICCOM products are available in more than 45 countries.

CONTENTS

	 Air conditioning	 Refrigeration	 Heating	Flowrate max	Discharge head max	Page	
PREMIUM RANGE	mini FLOWATCH® 2				15 l/h	10 m	5
	mini FLOWATCH® 2 Silence				15 l/h	10 m	6
	mini FLOWATCH® 1				10 l/h	10 m	7
	FLOWATCH® DESIGN				15 l/h	10 m	8
	FLOWATCH® VISION				15 l/h	10 m	9
	SUNNY FLOWATCH® CLIM				15 l/h	10 m	10
	FLOWATCH® TANK				788 l/h	5.5 m	11
Centrifugal pump CP08				60 l/h	110 cm	12	
ECO RANGE	mini FLOWATCH® 0 <i>50Hz only</i>				10 l/h	10 m	14
	ECO FLOWATCH®				13.2 l/h	10 m	15
	ECO LINE				13.2 l/h	10 m	16
	MAXI ECO FLOWATCH®				40 l/h	10 m	17
	FlowIta +				13.2 l/h	10 m	18
	ECOTANK+ 1.2 / ECOTANK+ 2.5				300 l/h	4.6 m	20
	DUO RANGE	mini FLOWATCH® 2 DUO				19 l/h	10 m
FLOWATCH® VISION DUO					19 l/h	10 m	22
SUNNY FLOWATCH® DUO					19 l/h	10 m	23

PREMIUM RANGE



ECO RANGE

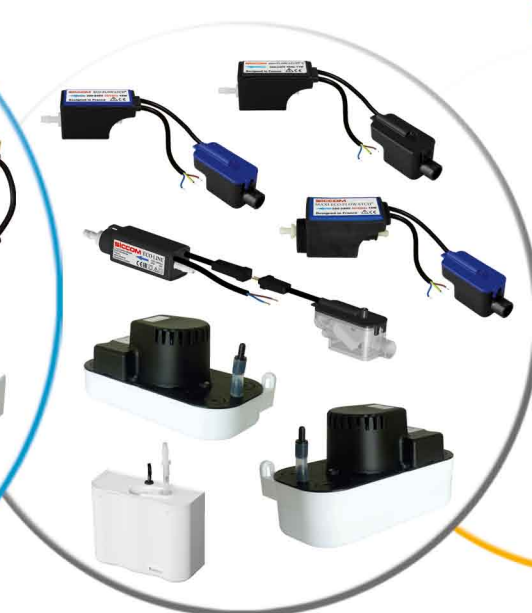

DUO RANGE



PREMIUM RANGE

Premium range is composed by high quality condensate pumps.

They are all equipped with an integrated alarm (except CP08) and include the entire technological expertise of SICCOM. Reliable, long lasting, silent and efficient, these pumps will perfectly answer to the installer's and final user's expectations.

	Application			Compatible appliance						Specifications			Type of installation				
	Air conditioning	Refrigeration	Heating	Wall-mounted air conditioner	Floor-mounted air conditioner	Ductable	Cassette	Refrigerated equipment	Gas condensing boiler	Flowrate (l/h)	Discharge head (m)	Noise level (dBA)	Inside the unit	Wall-mounted against the unit	Remotely	Inside a duct	Floor-mounted
mini FLOWATCH® 2	X			X	X	X				15	10	20.2	X		X	X	
mini FLOWATCH® 2 Silence	X			X	X	X				15	10	19.7	X		X	X	
mini FLOWATCH® 1	X			X	X	X				10	10	21	X		X	X	
FLOWATCH® DESIGN	X			X						15	10	20.2				X	
FLOWATCH® VISION	X			X						15	10	19.7		X			
SUNNY FLOWATCH® CLIM	X	X		X	X	X	X	X		15	10	20.2			X		X
FLOWATCH® TANK	X	X	X	X	X	X	X	X	X	788	5.5	47			X		X
Centrifugal pump CP08	X							X		60	1.1	26	X				

mini FLOWATCH® 2



mini FLOWATCH® 2 Silence



mini FLOWATCH® 1



FLOWATCH® DESIGN



FLOWATCH® VISION



SUNNY FLOWATCH® CLIM



FLOWATCH® TANK



Centrifugal pump CP08



mini FLOWATCH® 2

Mini solenoid pump reliable and silent for the condensate removal of air conditioners up to 10kW / 36000BTU.

Ref: DE05LC4400

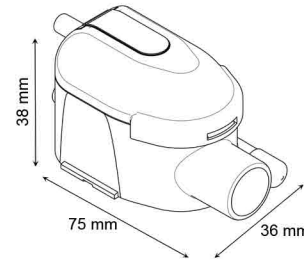
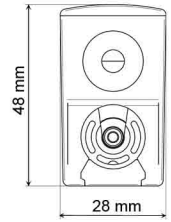
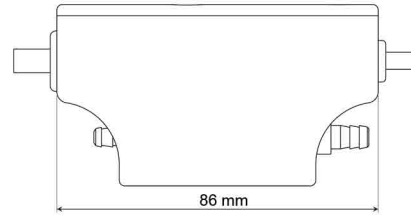

Hose diameters
Suction - 4/6mm - Supplied
Discharge - 6/9 mm - Not supplied

Benefits



20.2 dBA

Very silent pump, suitable for an installation in any room.



IP64 protection rating

Protected from water and dust ingress.



Quick connectors Plug & Play

Makes installation and maintenance easier.



Clear reservoir

Makes the maintenance easier thanks to an easy viewing of the reservoir state.

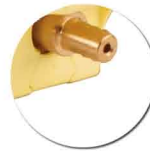

Brass outlet

More solid and reliable than plastic outlet.



Accessories included

All necessary accessories are included in the box.

Specifications

Flowrate max	15 l/h
Suction head max	2 m
Discharge head max	10 m
Electrical power	19W
Voltage	220-240V 50/60Hz
Alarm	NO-NC 5A
Noise level	20.2 dBA
Protection rating	IP64
Thermal protection	Yes
Operating cycle*	100%
Power / alarm cable length	1.6 m
Dimensions	86 x 28 x 48 mm / 75 x 38 x 36 mm

* The pump is able to run 100% of the time if necessary.

Flowrate

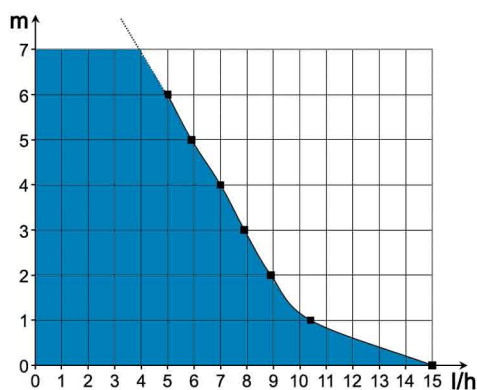

Pack contents



Pump - Reservoir with air-vent tube - Power / alarm cable - Reservoir stand - Double-side adhesive - Inlet tube - Suction tube 1.8m - 1 clamp

Recommended accessory: Kit Silence
Make the installation easier and reduce the noise level (19,7 dBA). Ref: GC1KFX2010



mini FLOWATCH® 2 Silence

Mini solenoid pump reliable and very silent for the condensate removal of air conditioners up to 10kW / 36000BTU.

Ref: DE05LCC280

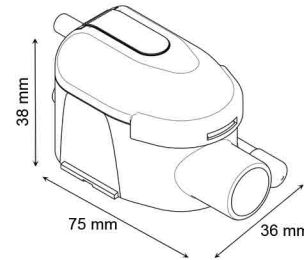
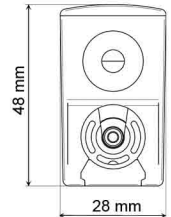
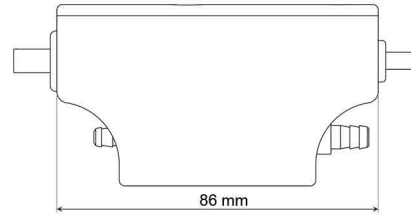

Hose diameters
Suction - 4/6mm - Supplied
Discharge - 6/9 mm - Not supplied



Benefits



19.7 dBA

Extremely silent pump, suitable for an installation in any room.



Pump stand

Makes the installation easier, and allows to reduce the pump vibrations.



Stop siphoning included

Allows to avoid all risk of negative discharge and to secure the pump functioning over time.



IP64 protection rating

Protected from water and dust ingress.



Quick connectors Plug & Play

Makes installation and maintenance easier.



Clear reservoir

Makes the maintenance easier thanks to an easy viewing of the reservoir state.



Brass outlet

More solid and reliable than plastic outlet.

Specifications

Flowrate max	15 l/h
Suction head max	2 m
Discharge head max	10 m
Electrical power	19W
Voltage	220-240V 50/60Hz
Alarm	NO-NC 5A
Noise level	19.7 dBA
Protection rating	IP64
Thermal protection	Yes
Operating cycle*	100%
Power / alarm cable lenght	1.6 m
Dimensions	86 x 28 x 48 mm / 75 x 38 x 36 mm

* The pump is able to run 100% of the time if necessary.

Flowrate

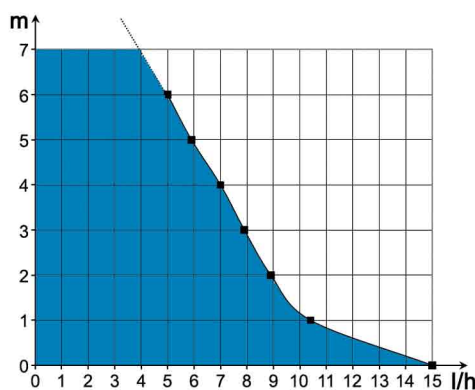

Pack contents

Pump - Reservoir with air-vent tube - Power / alarm cable - Pump stand - Reservoir stand - Double-side adhesive - Inlet tube - Suction tube 1.8m - 1 clamp



mini FLOWATCH® 1

Mini solenoid pump solid and silent for the condensate removal of air conditioners up to 10kW / 36000BTU.

Ref box version: DE05LC1520
Ref blister version: DE05LCB670

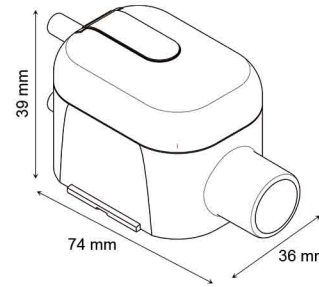
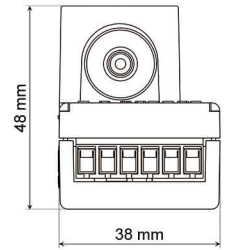
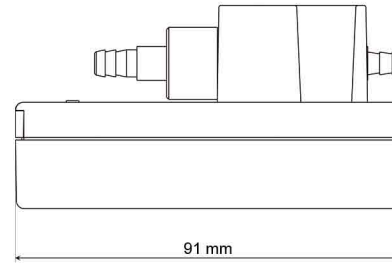

Hose diameters
Suction - 4/6 mm - Supplied
Discharge - 4/6 mm - Not supplied
(or 6/9 mm with the connector supplied)

Specifications

Flowrate max	10 l/h
Suction head max	2 m
Discharge head max	10 m
Electrical power	19W
Voltage	220-240V 50/60Hz
Alarm	NO-NC 5A
Noise level	21 dBA
Protection rating	IP20
Thermal protection	Yes
Operating cycle*	100%
Power / alarm cable lenght	Not supplied
Dimensions	91 x 38 x 48 mm / 74 x 39 x 36 mm

* The pump is able to run 100% of the time if necessary.

Benefits

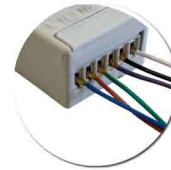

Electrical terminal block

Power and alarm wires are connected directly on the pump block thanks to the electrical terminal block.



Brass outlet

More solid and reliable than plastic outlet.



21 dBA

Silent pump, suitable for an installation in any room.



Accessories included

All accessories are included in the box.

Flowrate

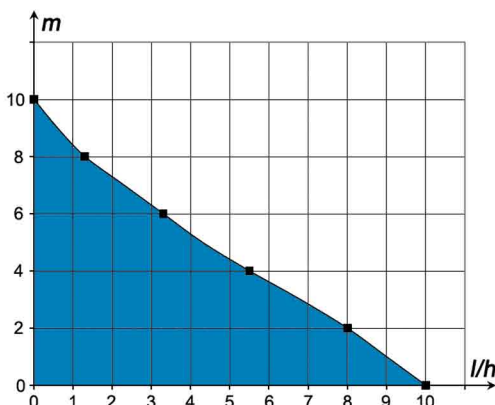

Pack contents

- Pump - Reservoir with air-vent tube -
- Power / alarm cable - Reservoir stand -
- Double-side adhesive - Inlet tube - Suction tube 1.8m - Reducer connector 4mm-6mm - 1 clamp

FLOWATCH® DESIGN

Complete kit, in-duct pump, for the condensate removal of air conditioners up to 10kW / 36000BTU.

Ref: DE05LC9460

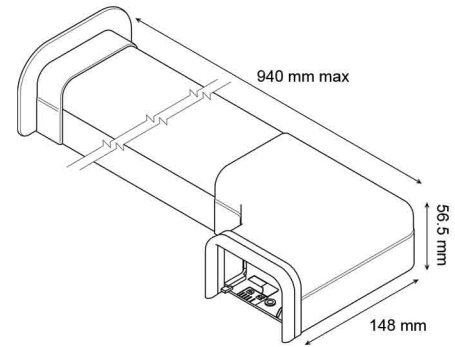
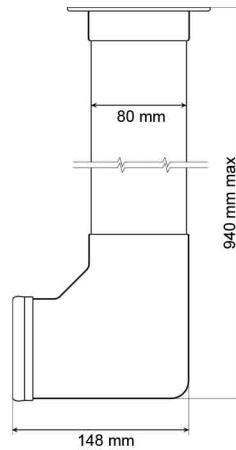

Hose diameters
Suction - 4/6 mm - Supplied
Discharge - 6/9 mm - Not supplied



Specifications

Flowrate max	15 l/h
Discharge head max	10 m
Electrical power	19W
Voltage	220-240V 50/60Hz
Alarm	NO-NC 5A
Noise level	20.2 dBA
Protection rating	IP64
Thermal protection	Yes
Operating cycle*	100%
Power / alarm cable lenght	1.6 m
Dimensions	80 x 55 x 800 mm

* The pump is able to run 100% of the time if necessary.

Benefits



mini FLOWATCH® 2 included
It assures a high reliability and an easy maintenance.



20.2 dBA
Very silent pump, suitable for an installation in any room.



IP64 protection rating
Protected from water and dust ingress.



Stop siphoning included
Allows to avoid all risk of negative discharge and to secure the pump functioning over time.



Nice design
Thanks to its shape and its finishing accessories (included), FLOWATCH® DESIGN offers great aesthetics qualities.



Kit pre-assembled
Pump is already installed in its duct. Installation is easy and quick.

Flowrate

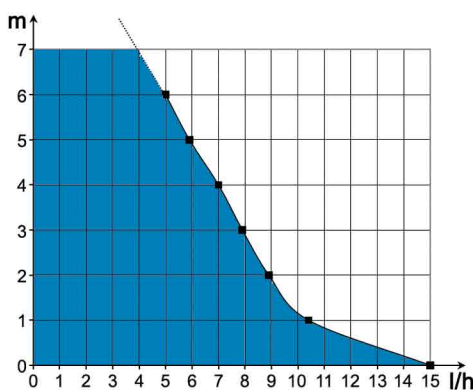

Pack contents

Duct with elbow- Finishing gasket - Finishing ceiling plate - Pump in absorber bracket - Reservoir with air-vent tube - Power / alarm cable - Reservoir stand - Inlet tube - Suction tube 0.25m - Screws and rawplugs



FLOWATCH® VISION

The only monoblock wall pump of the market, installed horizontally or vertically, for the condensate removal of air conditioners up to 10kW / 36000BTU.

Ref: DE05LCB900

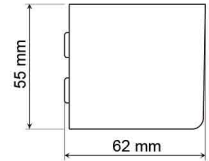
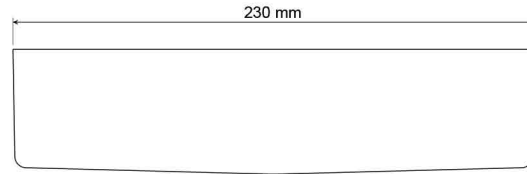

Hose diameter

Discharge - 6/9 mm - Not supplied



Benefits

4 possible installations



World premiere - Can be installed horizontally or vertically, on the right or on the left of the air conditioner.

Easy maintenance

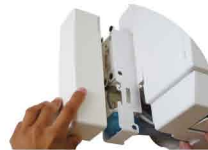

Access to the pump elements (reservoir, tubes etc.) is made by removing the cover.

19.7 dBA



Extremely silent pump, suitable for an installation in any room.

Record size



Thanks to its small size, the FLOWATCH® VISION is the most discreet and aesthetic monoblock wall pump of the market.

Specifications

Flowrate max	15 l/h
Discharge head max	10 m
Electrical power	19W
Voltage	220-240V 50/60Hz
Alarm	NO-NC 5A
Noise level	19.7 dBA
Protection rating	IPX3
Thermal protection	Yes
Operating cycle*	100%
Power / alarm cable lenght	1.4 m
Dimensions	230 x 61.5 x 55 mm

* The pump is able to run 100% of the time if necessary.

Reservoir with removing filter

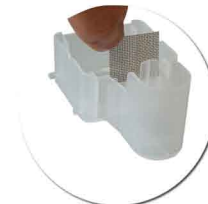

Prevents dust and particles to damage the pump. Easy to clean.

Pack contents



Pump - Reservoir for horizontal installation
- Reservoir for vertical installation - Inlet tube - Screws and rawlplugs - 1 clamp

Flowrate

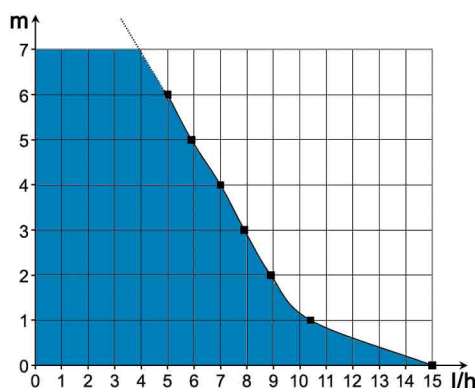

SUNNY FLOWWATCH® CLIM

Mini tank pump (solenoid) for the condensate removal of air conditioners up to 10kW / 36000BTU.

Ref: DE05RCC060

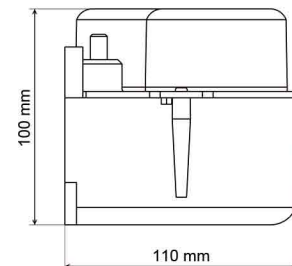
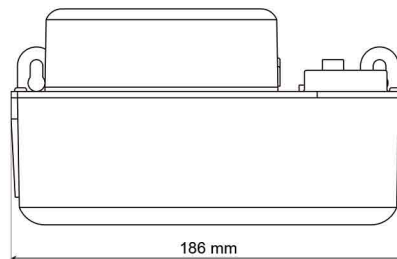

Hose diameter

Discharge - 6/9 mm - Not supplied



Specifications

Flowrate max	15 l/h
Discharge head max	10 m
Electrical power	19W
Voltage	220-240V 50/60Hz
Alarm	NO-NC 5A
Noise level	20.2 dBA
Protection rating	IPX4
Thermal protection	Yes
Operating cycle*	100%
Power / alarm cable lenght	1.5m / 1.3m
Dimensions	186 x 110 x 100 mm

* The pump is able to run 100% of the time if necessary.

Benefits



20.2 dBA

Very silent pump, suitable for an installation in any room.



Compact tank pump

The SUNNY FLOWWATCH® CLIM offers the best tank capacity/pump size of the market.



IPX4 protection rating

Protected from water splashes.



Removable integrated filter

Prevent dust and particles to damage the pump. Easy to remove and to clean.



Mounting brackets

Thanks to its mounting brackets (and screws and rawplugs supplied), pump can be easily fixed to the wall.

Flowrate

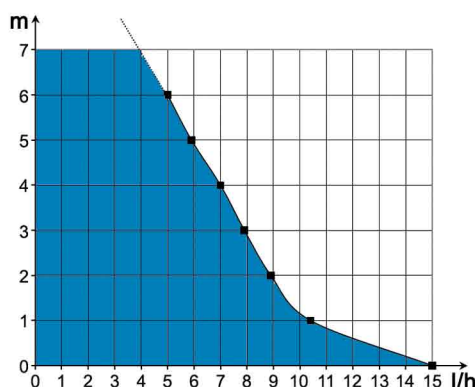

Pack contents

Pump - Inlet tube - Screws and rawplugs

FLOWATCH® TANK

Centrifugal pump high efficiency for the removal of acid and charged condensates of gas condensing boilers.

Ref: DE13QCA700



pH > 2.5

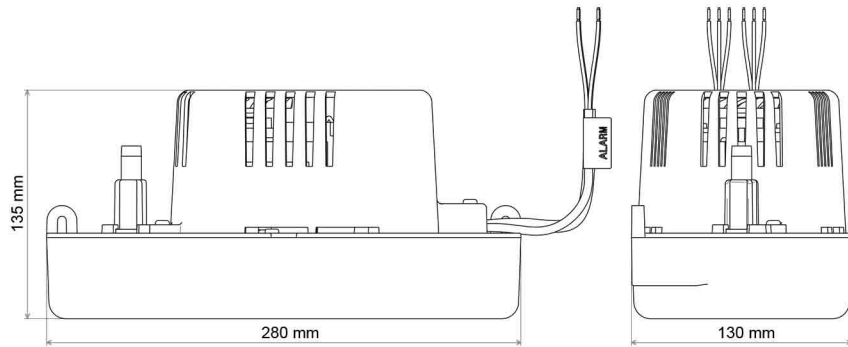

pH > 2.5

Hose diameter

Discharge - 9/12 mm or 6/9 mm - Not supplied



Benefits



High efficiency

Flowrate 788 l/h
Discharge head 5.5 m

180°



Reversible tank

Allows the FLOWATCH® TANK to be installed in any configuration.



Removable check valve

The check valve supplied can be removed easily (1/4 turn) to be cleaned.



2 possible outlet diameters

Original outlet for 9/12mm tube
+ reducer for 6/9mm tube



Condensate inlet reducer

Guarantees an easy connection to the boiler.

Specifications

Flowrate max	788 l/h
Discharge head max	5.5 m
pH tolerated	pH > 2.5
Max temperature of condensates	60°C
Electrical power	80W
Voltage	220-240V 50/60Hz
Alarm	NO-NC 3A
Noise level	47 dBA
Protection rating	IP20
Thermal protection	Yes
Operating cycle*	30%
Power / alarm cable lenght	2m / 1m
Dimensions	280 x 130 x 135 mm

* The pump is able to run 30% of the time if necessary. (ex 3s ON / 7s OFF)

Flowrate

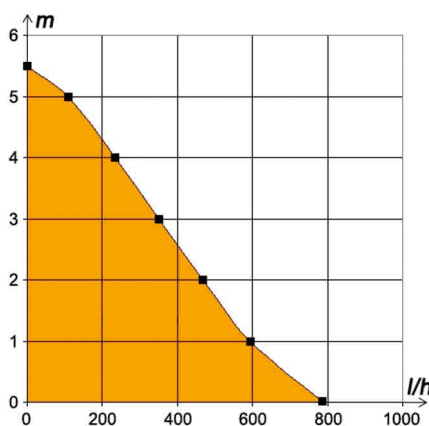

Pack contents

Pump with check valve, 3 taps - Inlet adaptor - 6/9mm outlet adaptor - Screws and rawplugs

Centrifugal pump CP08

Universal centrifugal pump dedicated to split cassettes.



Ref: CP08SC6641

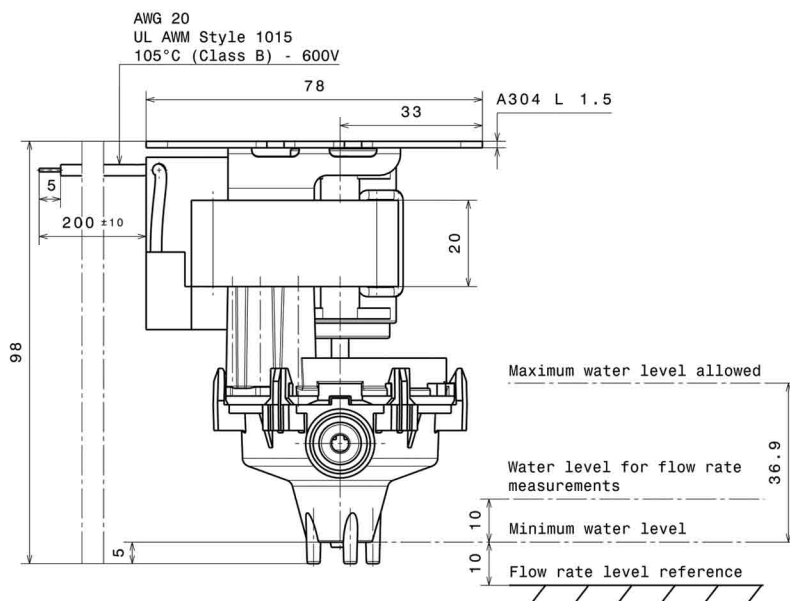

Specifications

Flowrate max	60 l/h
Discharge head max	110 cm
Electrical power	8W
Voltage	220-240V 50/60Hz
Noise level	26 dBA @ 30cm
Protection rating	IP54
Temperature rise	66 K
Operating cycle*	100%
Outlet tube	Ø 14 mm
Dimensions	82.5 x 76 x 97.3 mm

* The pump is able to run 100% of the time if necessary.

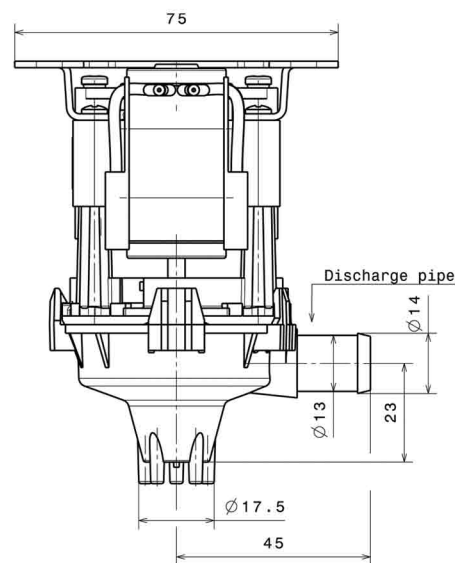

Flowrate

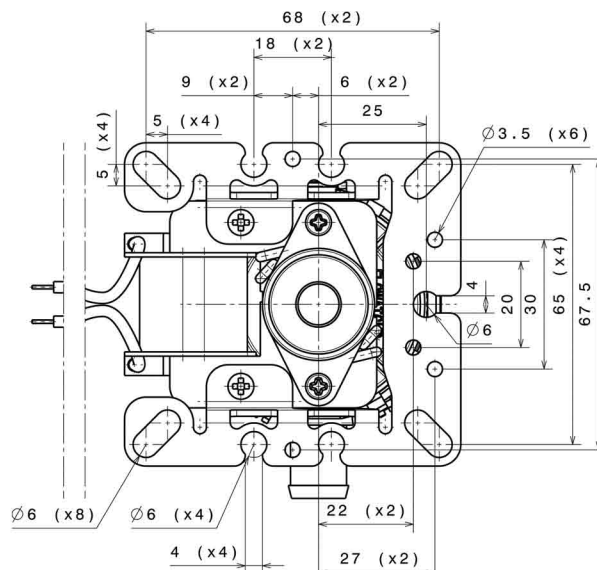
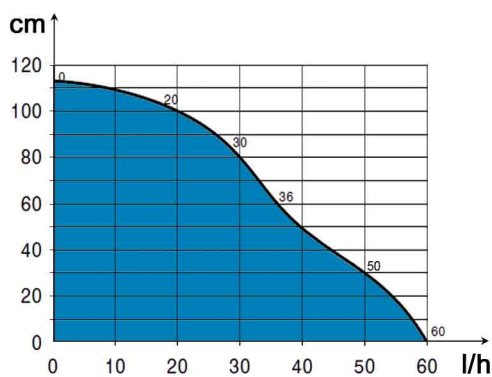

€CO RANGE

ECO range has been created by SICCOM in 2014 in order to propose entry-level pumps at prices even more attractive. Building on the Premium range expertise, SICCOM has developed a range of simple, reliable and easy-to-install pumps.

	Application			Compatible appliance						Specifications			Type of installation				
	Air conditioning	Refrigeration	Heating	Wall-mounted air conditioner	Floor-mounted air conditioner	Ductable	Cassette	Refrigerated equipment	Gas condensing boiler	Flowrate (l/h)	Discharge head (m)	Noise level (dBA)	Inside the unit	Wall-mounted against the unit	Remotely	Inside a duct	Floor-mounted
mini FLOWATCH® 0	X			X	X	X				10	10	-	X		X	X	
ECO FLOWATCH®	X			X	X	X				13.2	10	-	X		X	X	
ECO LINE	X			X	X	X				13.2	10	-	X		X	X	
MAXI ECO FLOWATCH®	X			X	X	X				40	10	23	X		X	X	
FlowIta+	X			X						13.2	10	-		X			
ECOTANK+ 1.2	X	X	X	X	X	X	X	X	X	300	4.6	-			X		X
ECOTANK+ 2.5	X	X	X	X	X	X	X	X	X	300	4.6	-			X		X

mini FLOWATCH® 0



ECO FLOWATCH®



ECO LINE



MAXI ECO FLOWATCH®



FlowIta+



ECOTANK+ 1.2



ECOTANK+ 2.5



mini FLOWATCH® 0

Mini solenoid pump simple and economic for the condensate removal of air conditioners up to 8kW / 27000BTU.

Ref: DE05LCB980

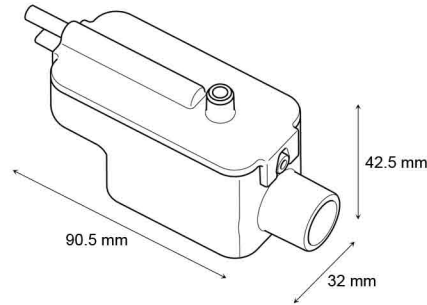
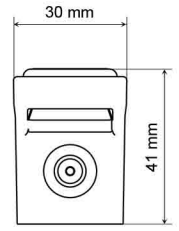
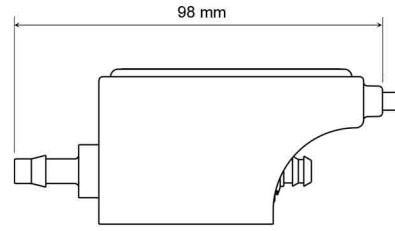
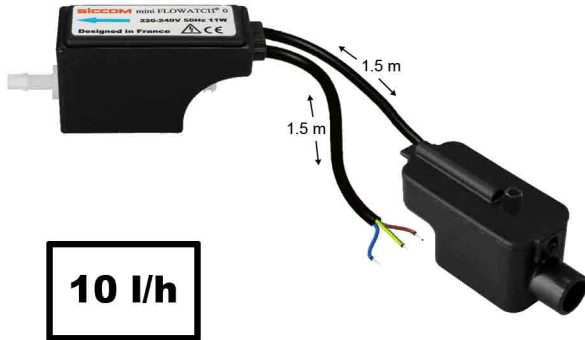

Hose diameters
Suction - 6/9 mm - Not supplied
Discharge - 6/9 mm - Not supplied

Specifications

Flowrate max	10 l/h
Suction head max	1.5 m
Discharge head max	10 m
Electrical power	11W
Voltage	220-240V 50Hz
Alarm**	No alarm
Noise level	N/C
Protection rating	IP20
Thermal protection	Yes
Operating cycle*	100%
Power cable lenght	1.5 m
Dimensions	98 x 30 x 41 mm / 90 x 32 x 42 mm

* The pump is able to run 100% of the time if necessary.

** Alarm option available on request.

Benefits



Removable reservoir

Can be easily unclipped in order to clean the reservoir and the float.



Integrated filter

Plastic filter integrated to the reservoir. It prevents big impurities to damage the pump.



Accessories included

All necessary accessories are included in the box.



Compact pump

Very small, pump and reservoir are easy to install.

Flowrate

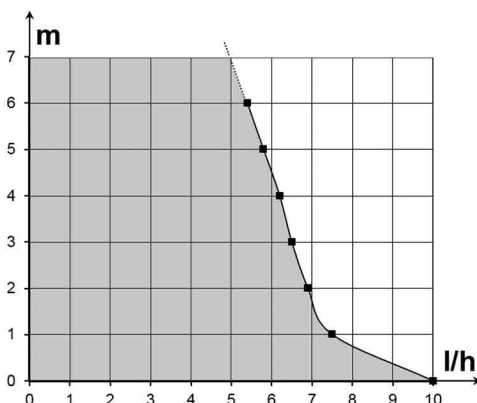

Pack contents



Pump - Reservoir - Double-side adhesive for reservoir fixing - Inlet tube - 3 clamps

ECO FLOWATCH®

Mini solenoid pump simple and economic for the condensate removal of air conditioners up to 10kW / 36000BTU.

Ref: DE05LCC190

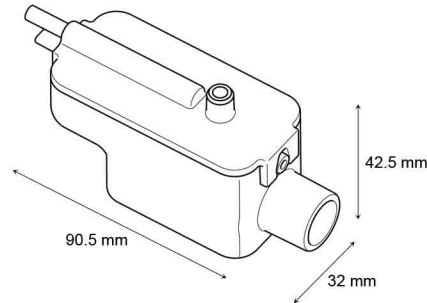
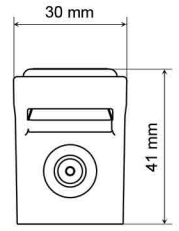
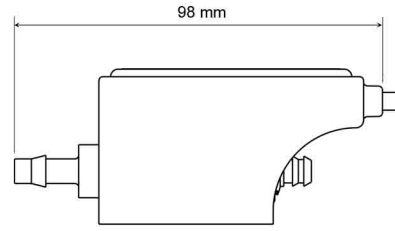
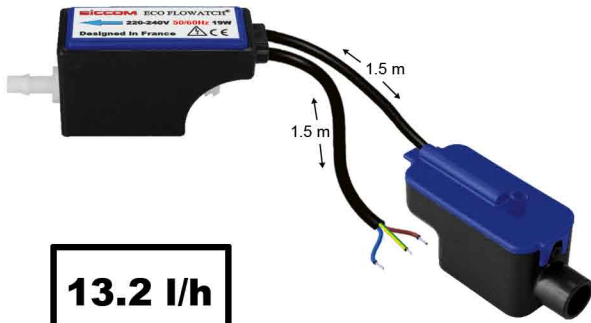

Hose diameters
Suction - 6/9 mm - Not supplied
Discharge - 6/9 mm - Not supplied

Specifications

Flowrate max	13.2 l/h
Suction head max	1.5 m
Discharge head max	10 m
Electrical power	19W
Voltage	220-240V 50/60Hz
Alarm**	No alarm
Noise level	N/C
Protection rating	IP20
Thermal protection	Yes
Operating cycle*	100%
Power cable lenght	1.5 m
Dimensions	98 x 30 x 41 mm / 90 x 32 x 42 mm

* The pump is able to run 100% of the time if necessary.

** Alarm option available on request.

Benefits



Removable reservoir

Can be easily unclipped in order to clean the reservoir and the float.



Integrated filter

Plastic filter integrated to the reservoir. It prevents big impurities to damage the pump.



Accessories included

All necessary accessories are included in the box.



Compact pump

Very small, pump and reservoir are easy to install.

Flowrate

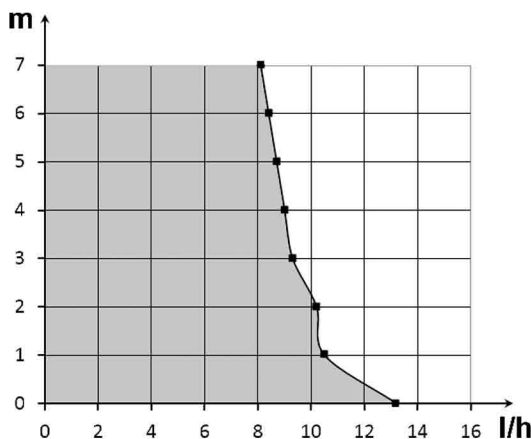

Pack contents



Pump - Reservoir - Double-side adhesive for reservoir fixing - Inlet tube - 3 clamps

Mini in-line pump (solenoid), ultra compact and easy to install, for the condensate removal of air conditioners up to 10KW / 36000BTU.

Ref: DE05SCC600

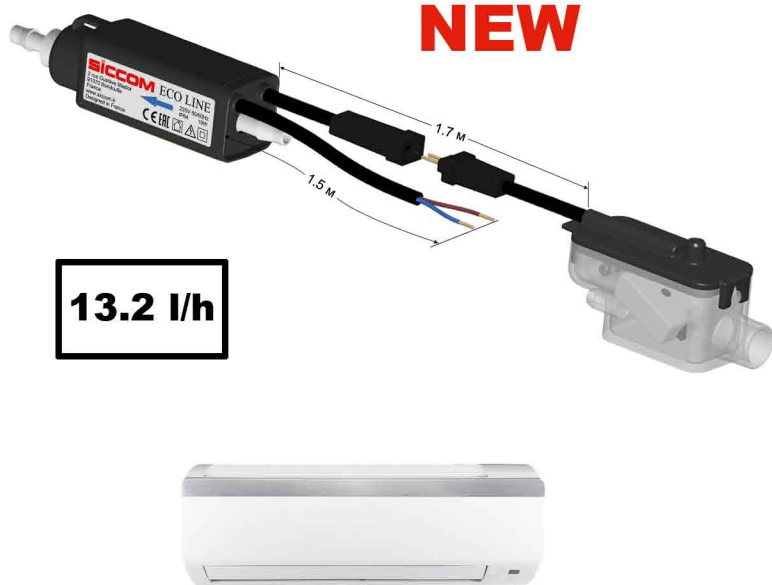

NEW

13.2 l/h

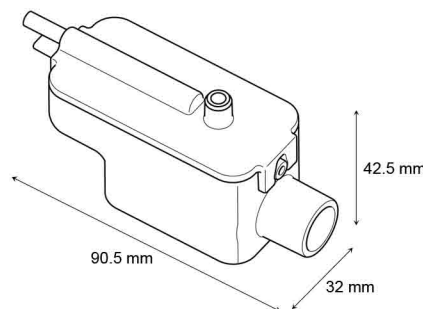
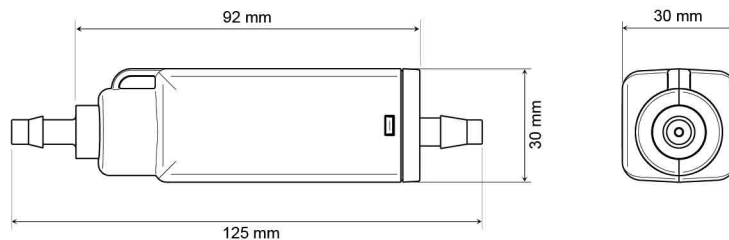

Hose diameters
Suction - 6/9 mm - Not supplied
Discharge - 6/9 mm - Not supplied

Specifications

Flowrate max	13.2 l/h
Suction head max	1.5 m
Discharge head max	10 m
Electrical power	19W
Voltage	220-240V 50/60Hz
Alarm**	No alarm
Noise level	N/C
Protection rating	IP64
Thermal protection	Yes
Operating cycle*	100%
Power cable length	1.5 m
Dimensions	125 x 30 x 30 mm / 90 x 32 x 42 mm

* The pump is able to run 100% of the time if necessary.

** Alarm option available on request.

Flowrate

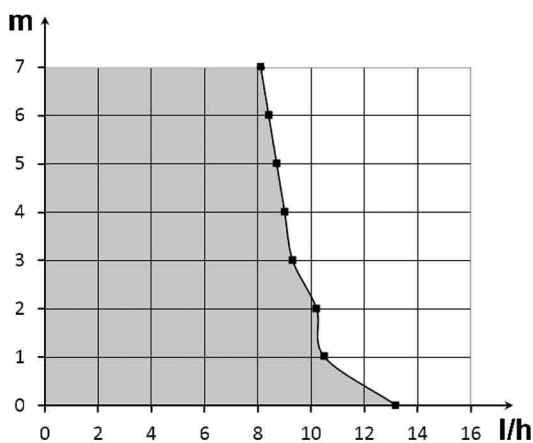

Benefits

ULTRA COMPACT pump

The most compact pump of the market!
Easy installation in a duct or inside the air conditioner.



IP64 protection rating

Protected from water and dust ingress.



Quick connectors Plug & Play

Makes installation and maintenance easier.



Removable clear reservoir

Allows a quick and easy viewing of the reservoir and the float. Easy to open and to clean.

Hanging bracket

This astucious hook allows to fix or hang the pump wherever you want (duct, false ceiling, inside de unit...).



Accessories included

All necessary accessories are included in the box.



Pack contents

Pump - Reservoir - Double-side adhesive for reservoir fixing - Inlet tube - 3 clamps



MAXI ECO FLOWATCH®

Maxi solenoid pump, compact and powerful, for the condensate removal of air conditioners up to 30kW / 100 000BTU.

Ref: DE40LCC300

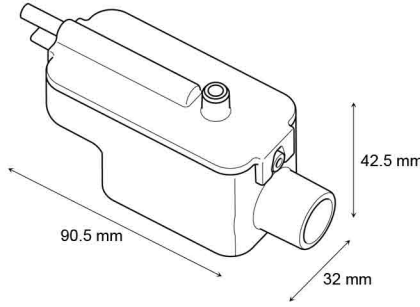
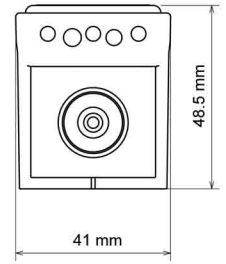
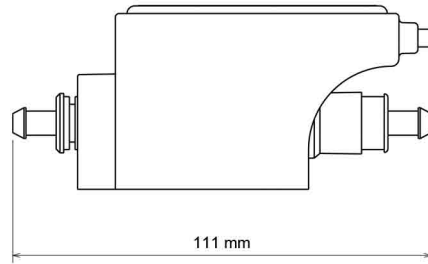

Hose diameters
Suction - 6/9 mm - Not supplied
Discharge - 6/9 mm - Not supplied

Specifications

Flowrate max	40 l/h
Suction head max	2 m
Discharge head max	10 m
Electrical power	16W
Voltage	220-240V 50/60Hz
Alarm**	No alarm
Noise level	23 dBA
Protection rating	IP20
Thermal protection	Yes
Operating cycle*	100%
Power cable lenght	1.5 m
Dimensions	111 x 41 x 48.5 mm / 82 x 32 x 39 mm

* The pump is able to run 100% of the time if necessary.

** Alarm option available on request.

Benefits



23 dBA

The only pump of the world to offer such a flowrate with such a low noise.



High efficiency

Flowrate 40 l/h
Discharge head 10 m



Removable reservoir

Can be easily unclipped in order to clean the reservoir and the float.



Integrated filter

Plastic filter integrated to the reservoir. It prevents big impurities to damage the pump.



Accessories included

All necessary accessories are included in the box.



Very compact pump

Very small, pump and reservoir are easy to install.



Pack contents

Pump - Reservoir - Double-side adhesive for reservoir fixing - Inlet tube - 3 clamps

Flowrate

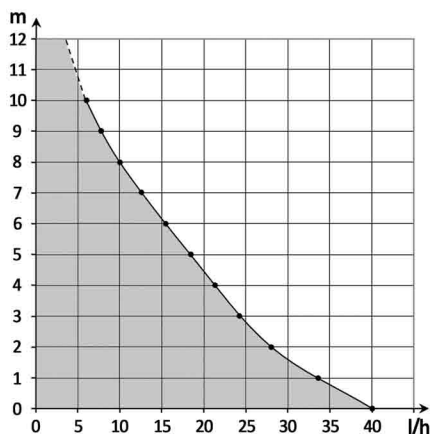

FlowIta+

Monoblock wall pump simple and economic for the condensate removal of air conditioners up to 10kW / 36000BTU.

Ref: DE05LCC440

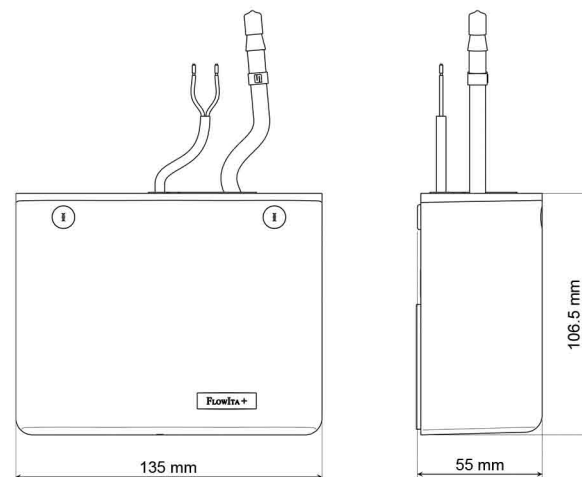

Hose diameter
Discharge - 6/9 mm - Not supplied

Specifications

Flowrate max	13.2 l/h
Discharge head max	10 m
Electrical power	19W
Voltage	220-240V 50/60Hz
Alarm	No alarm
Noise level	N/C
Protection rating	IP20
Thermal protection	Yes
Operating cycle*	100%
Power cable length	0.8 m
Dimensions	135 x 106.5 x 55 mm

* The pump is able to run 100% of the time if necessary.

Benefits



Anti-vibration stand

Reduces vibrations and noise level of the pump.



185 ml

Integrated reservoir

The 185 ml reservoir allows a reduction of pump cycle number.



Accessories included

All necessary accessories are included in the box.



Quick installation

The FlowIta+ can be installed easily and quickly underneath any air conditioner.



Pack contents

Pump - Screws and rawplugs

Flowrate

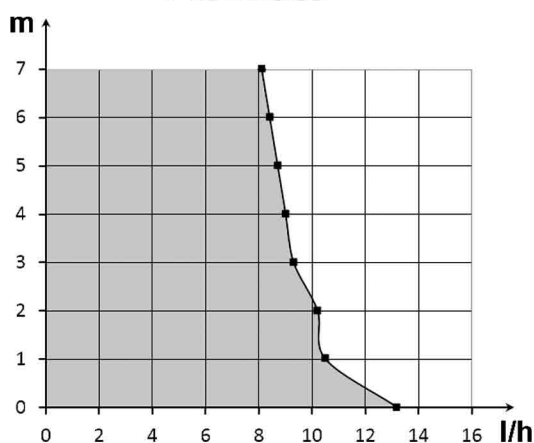

ECOTANK+ 1.2 / 2.5

Centrifugal tank pump for the removal of condensates from air conditioners, refrigerated displays or gas condensing boilers.

Ref ECOTANK+ 1.2: DE12QCC610
Ref ECOTANK+ 2.5: DE25QCC620



pH > 2.5



Benefits

Universal electric plug

Power/alarm cable can be taken off, making easy installation and maintenance.



Outlet for 6/9 or 9/12 mm tube

Thanks to its connector supplied, the discharge can be made with a 6/9mm or a 9/12mm tube.



High capacity tank

Thanks to its 2.5 l tank, the ECOTANK+ 2.5 reduces the number of pumping cycles and answers to a great deal of applications.



Compact tank pump

With only 129mm height, the ECOTANK+ 1.2 fits easily in any space.



Reversible tank

Turning the tank allows to fit in any configuration.



Pack contents

Pump - Cable power / alarm - 6/9mm outlet adaptor - Screws and rawlplugs



Specifications

Flowrate max	300 l/h
Discharge head max	4.6 m
pH tolerated	pH > 2.5
Max temperature of condensates	40°C
Electrical power	65W
Voltage	230V 50Hz
Alarm	NO-NC 3A
Noise level	N/C
Protection rating	IP20
Thermal protection	Yes
Operating cycle*	30%
Power cable lenght	1.5 m
Dimensions ECOTANK+ 1.2	280 x 130 x 129 mm
ECOTANK+ 2.5	280 x 130 x 159 mm

* The pump is able to run 30% of the time if necessary. (ex 3s ON / 7s OFF)

Flowrate

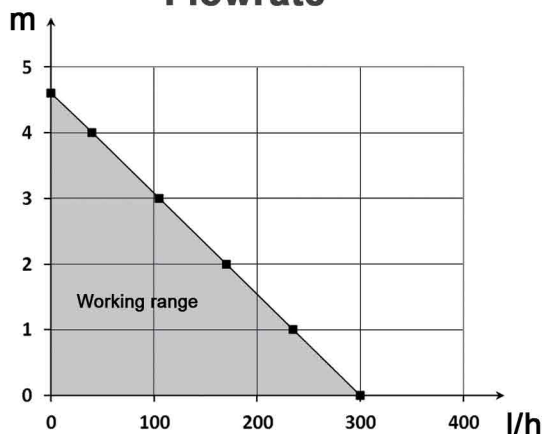

DUO RANGE

pH > 2.5

for gas condensing boilers <60 kW / 200 000 BTU

The DUO range has been especially developed for removing condensates from gas condensing boilers. SICCOM proposes innovative products in order to answer to technical and aesthetical expectations of both instaler and final user. These pumps are alternatives to centrifugal tank pumps usually used for this application, such as FLOWATCH® TANK (Premium range) and ECOTANK+ (ECO range).

	Application			Compatible appliance						Specifications			Type of installation				
	Air conditioning	Refrigeration	Heating	Wall-mounted air conditioner	Floor-mounted air conditioner	Ductable	Cassette	Refrigerated equipment	Gas condensing boiler	Flowrate (l/h)	Discharge head (m)	Noise level (dBA)	Inside the unit	Wall-mounted against the unit	Remotely	Inside a duct	Floor-mounted
mini FLOWATCH® 2 DUO	X		X	X	X	X			X	19	10	19.7	X		X	X	
FLOWATCH® VISION DUO	X		X	X					X	19	10	19.7		X			
SUNNY FLOWATCH® DUO	X	X	X	X	X			X	X	19	10	20.2			X		X

mini FLOWATCH® 2 DUO



FLOWATCH® VISION DUO



SUNNY FLOWATCH® DUO



mini FLOWATCH® 2 DUO

Mini solenoid pump reliable and silent for the condensate removal of gas condensing boilers up to 60kW / 200 000BTU.

Ref: DE05LCC500



pH > 2.5

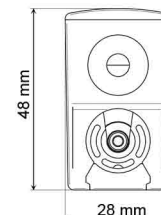
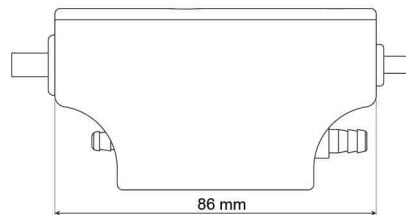

pH > 2.5

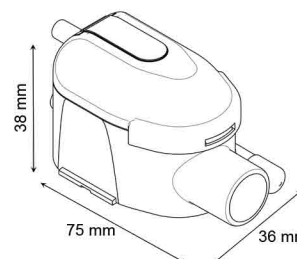

Hose diameters
Suction - 4/6mm - Supplied
Discharge - 6/9 mm - Not supplied



Benefits



19.7 dBA

Extremely silent pump, suitable for an installation in any room.



Quick connectors Plug & Play

Makes installation and maintenance easier.



Treated brass outlet

This brass outlet is specially treated to support acid condensates, and is more solid and reliable than plastic outlet.



IP64 protection rating

Protected from water and dust ingress.



Clean reservoir

Make the maintenance easier thanks to an easy viewing of the reservoir state.



Kit Silence supplied

Pump stand and reservoir stand make the installation easier and reduce the noise level.

Specifications

Flowrate max	19 l/h
Suction head max	0.5 m
Discharge head max	10 m
pH tolerated	pH > 2.5
Electrical power	19W
Voltage	220-240V 50/60Hz
Alarm	NO-NC 5A
Noise level	19.7 dBA
Protection rating	IP64
Thermal protection	Yes
Operating cycle*	100%
Power / alarm cable length	1.6 m
Dimensions	86 x 28 x 48 mm / 75 x 38 x 36 mm

* The pump is able to run 100% of the time if necessary.

Flowrate

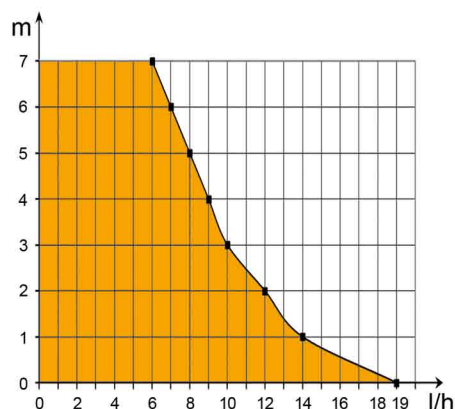

Pack contents



Pump - Reservoir with air-vent tube - Power / alarm cable - Pump stand - Reservoir stand - Double-side adhesive - Inlet tube - Suction tube 0.25m - 1 clamp

FLOWATCH® VISION DUO

SICCOM
INNOVATIVE VISION

Monoblock wall pump (solenoid), silent and innovative, for the condensate removal of gas condensing boilers up to 60kW / 200 000BTU.

Ref: DE05LCC510



pH > 2.5

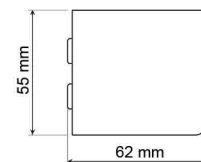
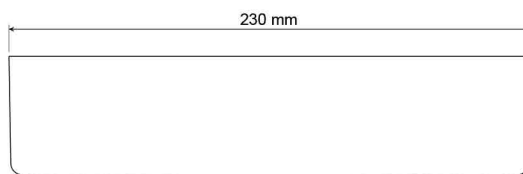

Hose diameter

Discharge - 6/9 mm - Not supplied

pH > 2.5



Specifications

Flowrate max	19 l/h
Discharge head max	10 m
pH tolerated	pH > 2.5
Electrical power	19W
Voltage	220-240V 50/60Hz
Alarm	NO-NC 5A
Noise level	19.7 dBA
Protection rating	IPX3
Thermal protection	Yes
Operating cycle*	100%
Power / alarm cable lenght	1.4 m
Dimensions	230 x 61.5 x 55 mm

* The pump is able to run 100% of the time if necessary.

Benefits

4 possible installations

World premiere - Can be installed horizontally or vertically, on the right or on the left of the boiler.



19.7 dBA

Extremely silent pump, suitable for an installation in any room.



Very easy maintenance

Access to the pump elements (reservoir, tubes etc.) is made by removing the cover.

Record size

Thanks to its small size, the FLOWATCH® VISION DUO is the most discreet and aesthetic monoblock wall pump of the market.



Reservoir with removable filter

Prevent dust and particles to damage the pump. Easy to clean.

Flowrate

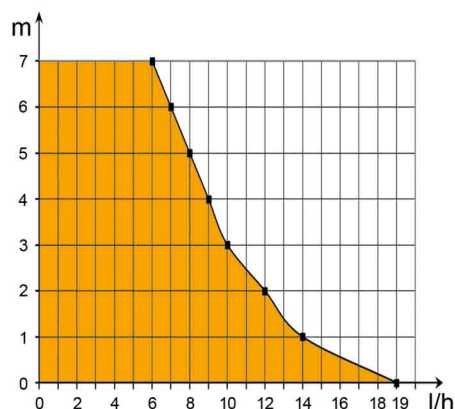

Pack contents



Pump - Inlet tube - Screws and rawlplugs - 1 clamp

SUNNY FLOWATCH® DUO

Mini tank pump (solenoid) for the condensate removal of gas condensing boilers up to 60kW / 200 000BTU.

Ref: DE05NCC090



pH > 2.5

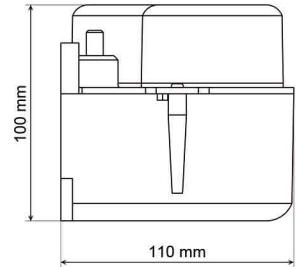
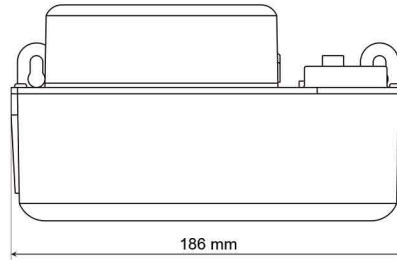

pH > 2.5

Hose diameter

Discharge - 6/9 mm - Not supplied

Benefits



20.2 dBA

Very silent pump, suitable for an installation in any room.



Compact tank pump

The SUNNY FLOWATCH® DUO offers the best tank capacity/pump size of the market.



IPX4 protection rating

Protected from water splashes.



Removable integrated filter

Prevent dust and particles to damage the pump. Easy to remove and to clean.



Mounting brackets

Thanks to its mounting brackets (and screws and rawplugs supplied), pump can be easily fixed to the wall.

Specifications

Flowrate max	19 l/h
Discharge head max	10 m
pH tolerated	pH > 2.5
Electrical power	19W
Voltage	220-240V 50/60Hz
Alarm	NO-NC 5A
Noise level	20.2 dBA
Protection rating	IPX4
Thermal protection	Yes
Operating cycle*	100%
Power / alarm cable lenght	1.5m / 1.3m
Dimensions	186 x 110 x 100 mm

* The pump is able to run 100% of the time if necessary.

Flowrate

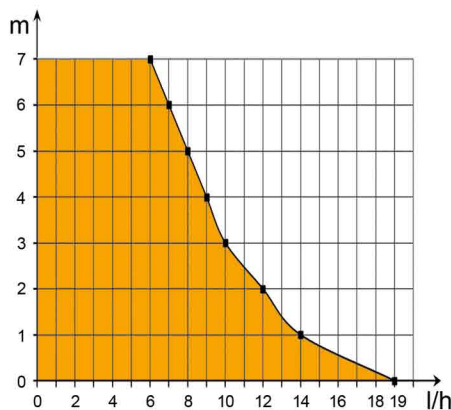

Pack contents

Pump - Inlet tube - Screws and rawplugs

Condensate removal pumps

SICCOM is established all across the world.
As an international manufacturer, we are committed to product quality and reliability.

Listening, communication and service are the three key values for our customer approach.

We will be delighted to provide further information, so please
CONTACT US.

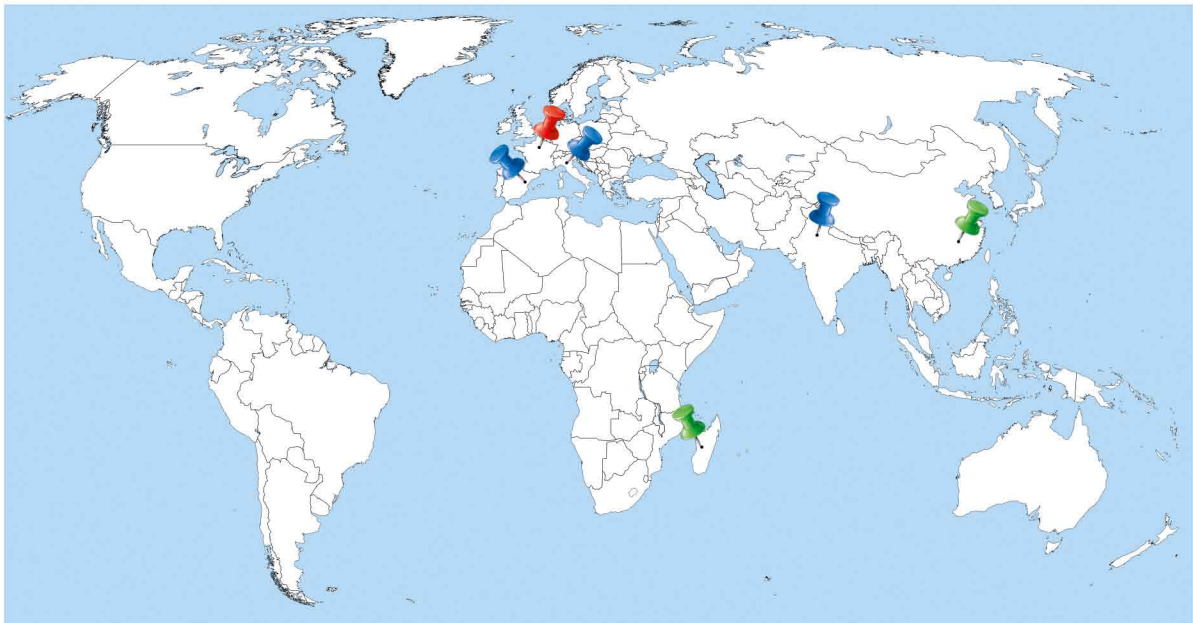

 Headquarter

 Offices

 Factories

SICCOM France - Headquarter

2, rue Gustave Madiot
ZI Les Bordes
91070 Bondoufle

Tel : +33 1 60 86 81 48 Fax : +33 1 60 86 87 57
Email : commercial@siccom.fr

SICCOM España

Barcelona
Tel : +34 622 487 110
Email : tducasse@siccom.fr

SICCOM India

New Delhi
Tel : +91 99 9900 3240
Email : djagga@siccom.fr

SICCOM Italia

Via San Francesco, 10
21047 Saronno, Varese
Tel/Fax : +39 02 96 36 21 40
Email : siccom_italia@tin.it

Your official distributor